

# TOP DEAL

**KSTOOLS**

WWW.KSTOOLS.COM

*No Limits!*

LA NOSTRA COMPETENZA CHIAVE:

LA QUALITÀ A UN PREZZO ECCEZIONALE!

EVOLUTION  
SERIES

**NOVITÀ**



Elenco pezzi completo

917.0255

1/4" + 3/8" + 1/2" + 5/16"

255 PEZZI  
PER SOLI

**149,90**



**EDELSTAHL**  
ROSTFREI

**i** **397**  
Ulteriori informazioni

**P<sub>10</sub>**

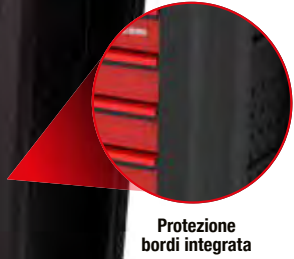
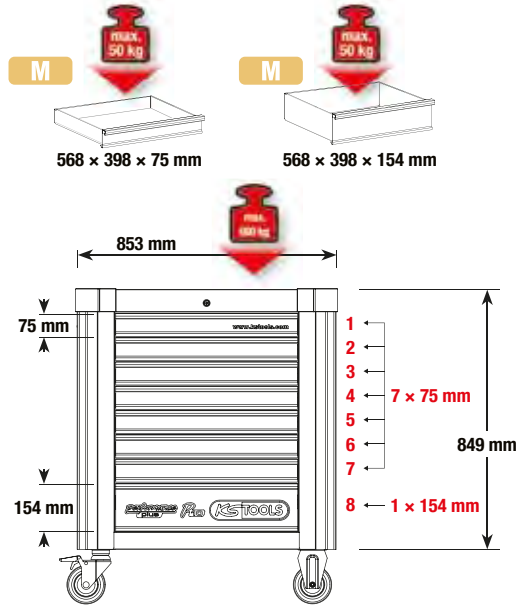

**SELEZIONA IL TUO PACCHETTO POWER**

810.7397

Options for the P10 toolbox:

- Supporto portarotoli
- Con supporto bevande
- Cuscinetto a sfera stabile
- Rotelle antistatiche con freno

**i** **397**  
Ulteriori informazioni

**P<sub>15</sub>**

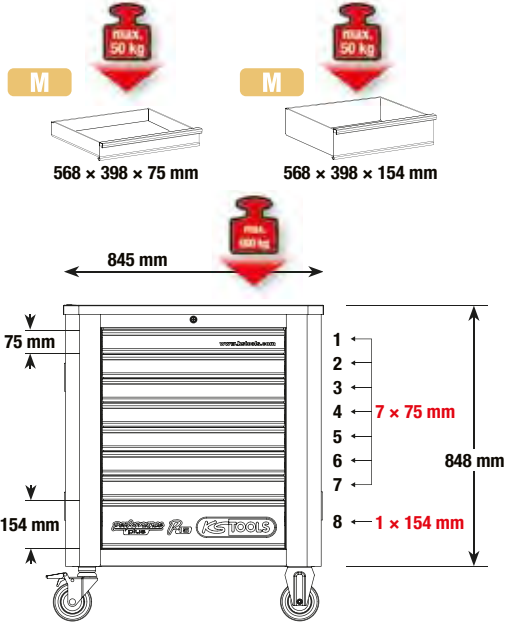

815.7397

**L'ASSORTIMENTO PERFETTO DA 397 PEZZI**



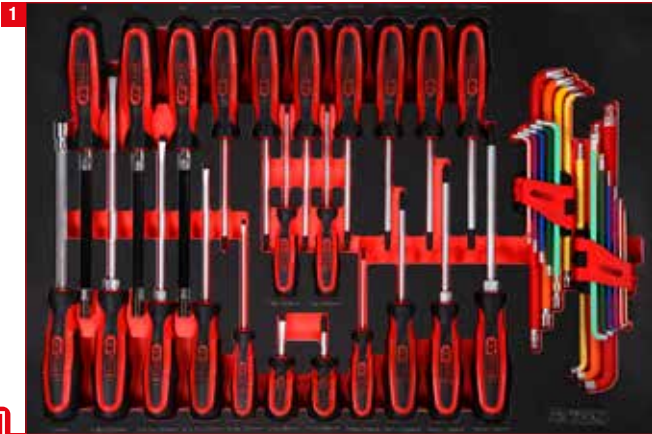

41 Serie di giraviti



41 Serie di giraviti

**2799,00**

810.7397 Carrello da officina P10 con 397 utensili



111 1/4" + 3/8" + 1/2" Serie di chiavi a bussola

**2899,00**

815.7397 Carrello da officina P15 con 397 utensili



28 Serie di pinze e lime



43 Kit servizio cambio olio e pneumatici

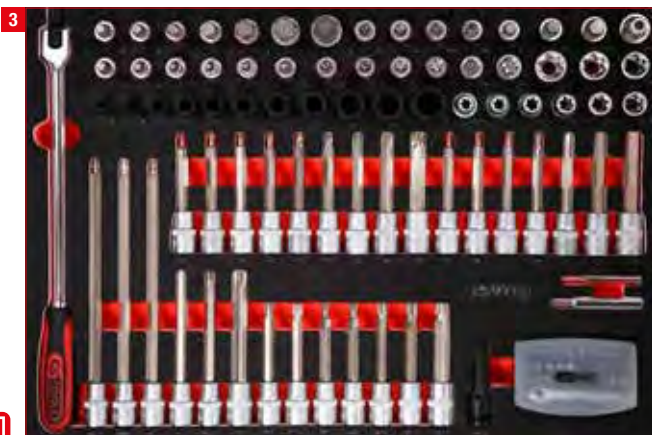

111 1/2" serie bussole a inserto

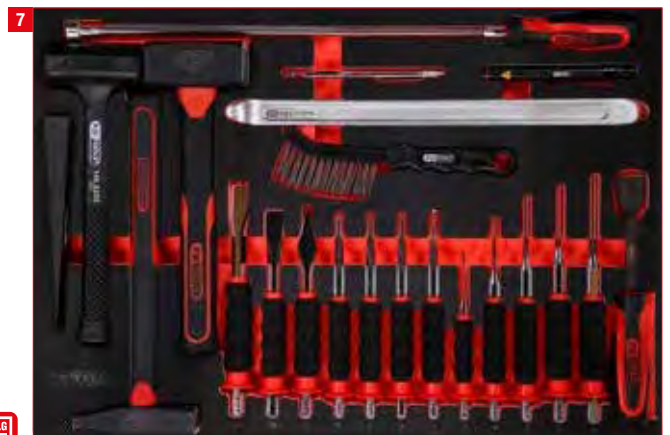

22 Serie di martelli e scalpelli



# BENVENUTI NEL



Ulteriori informazioni



## 3899,00



Protezione bordi integrata



Con supporto bevande



Cuscinetto a sfera stabile



Rotelle antistatiche con freno



Serratura chiudibile

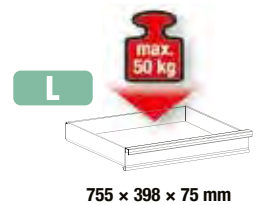
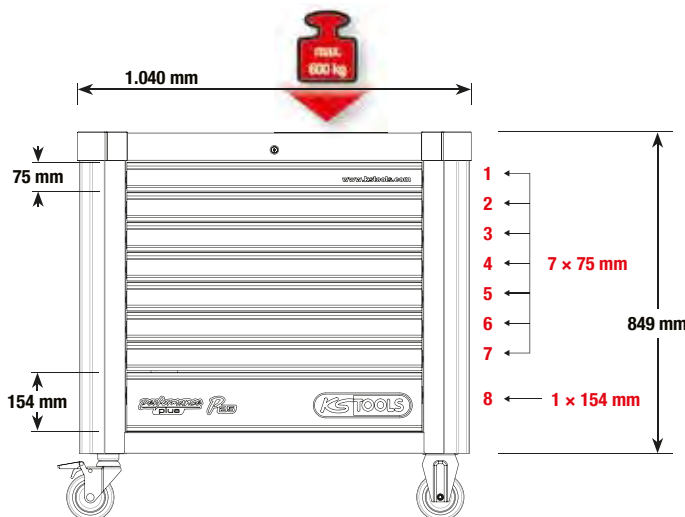

825.8564



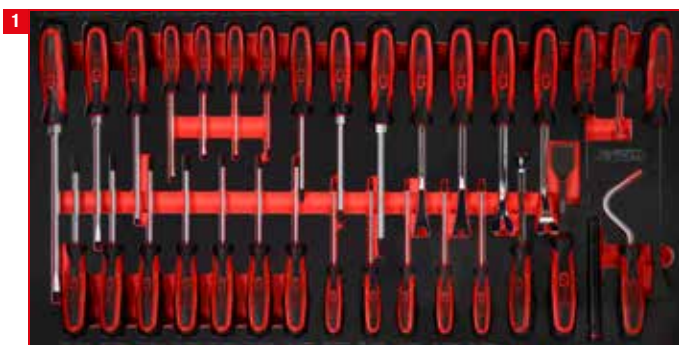

Serie di giraviti

33



1/4" + 3/8" Serie di chiavi a bussola

213



1/2" Serie di chiavi a bussola

86



Serie di giraviti

57



Serie di giraviti

54

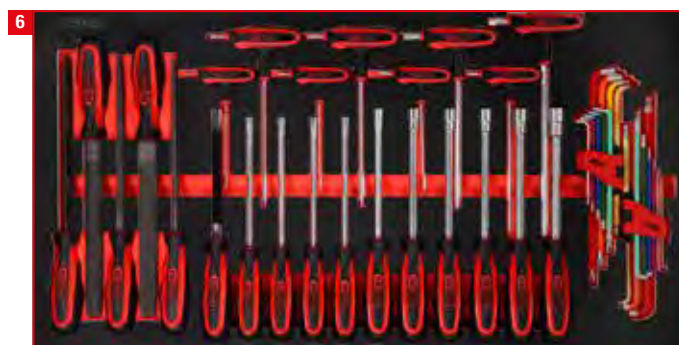

Serie di giraviti e lime

42

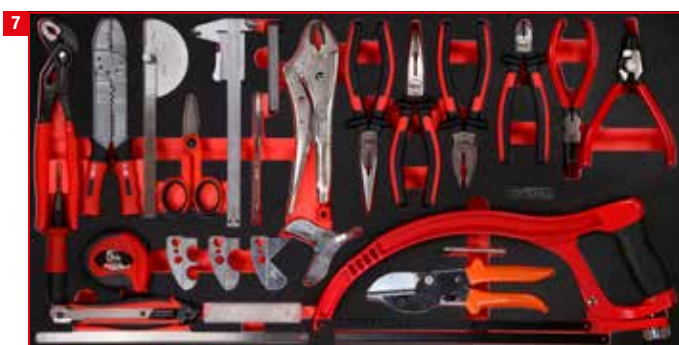

Serie di giraviti e pinze

39



Serie di martelli - scalpelli e bussole per avvitatori a impulsivi

40



# DI QUANTI CARRELLI HAI BISOGNO?



Rivestimento in gommapiuma di eccellente qualità incluso, spessore 10 mm



Serratura a cilindro



Con autoinserimento e funzione SOFT-CLOSE



Foratura quadra per accessori



2 x freni per ruote pivotanti Ø ruote: 125 mm

## ECO Line

# 509,00

SENZA UTENSILI



897.0007

Ulteriori informazioni

Dati tecnici:	Eco Line 897.0007	Racing Line 826.0007
Portata totale:	300,0 kg	350,0 kg
Portata di ogni cassetto:	25,0 kg	30,0 kg
autoinserimento e funzione SOFT-CLOSE:	✓	✗
Diametro ruota:	125,0 mm	125,0 mm
Freno della ruota:	✓	✓
Con serratura centrale:	✓	✓
Bloccaggio di ogni singolo cassetto:	✗	✓
Altezza:	1014,0 mm	976,0 mm
Larghezza:	748 mm	788 mm
Profondità:	459,0 mm	496,0 mm
Misure interne cassetto:	565 x 395 mm	565 x 395 mm
Con protezione angoli e spigoli in poliuretano:	✗	✓
Foratura quadra per accessori:	✓	✓
Numero cassette da:	7	7
spessore della lamiera:	0,8 mm	0,9 mm
Impugnatura cassette a banda:	✓	✓
Estensione del cassetto:	100 %	90 %
Piano di lavoro con scomparti per piccoli pezzi:	✗	✓
Piani di lavoro con inserti in schiuma:	✓	✗
Cassetti scorrevoli su guide con cuscinetti a sfera:	✓	✓
Con maniglione laterale in metallo:	✓	✓

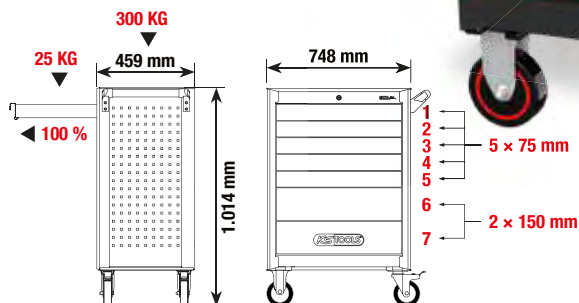

## L'IMBARAZZO DELLA SCELTA? SCELTA DI QUALITÀ!

## RACING Line



Piano di lavoro in ABS con scomparti per la minuteria



Serratura a cilindro



Il bloccaggio di ogni singolo cassetto impedisce aperture non desiderate



Foratura quadra per accessori



2 x freni per ruote pivotanti Ø ruote: 125 mm

# 569,00

SENZA UTENSILI



826.0007

Ulteriori informazioni

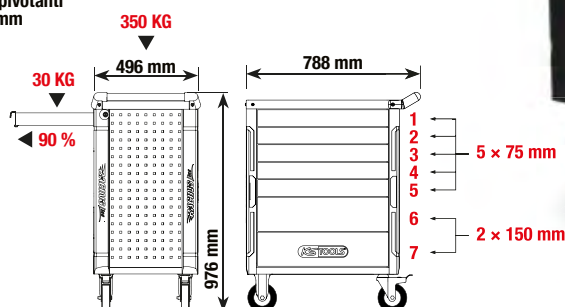

**ECO** *line*

Con 7 cassetti e 215 utensili premium

**799,90**

897.7215



## ASSORTIMENTO BASE - 215 PZ

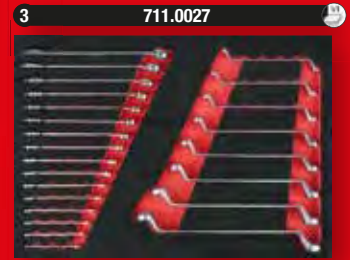

Ulteriori informazioni

**RACING** *line*

Con 7 cassetti e 215 utensili premium

**859,90**

826.7215

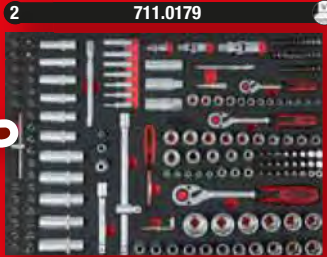

**ECO** *line*

Con 7 cassetti e 515 utensili premium

**1089,90**

897.7515



## ASSORTIMENTO UNIVERSALE - 515 PZ

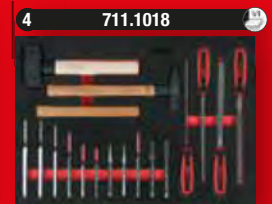
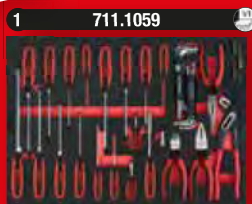

**RACING** *line*

Con 7 cassetti e 515 utensili premium

**1149,90**

826.7515

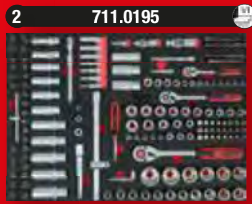

Ulteriori informazioni

**ECO** *line*

Con 7 cassetti e 598 utensili premium

**1549,90**

897.7598

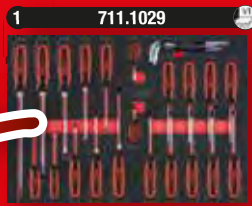

## ASSORTIMENTO POWER - 598 PZ



**RACING** *line*

Con 7 cassetti e 598 utensili premium

**1609,90**

826.7598

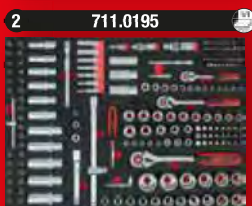

Ulteriori informazioni



- DIN 3110 / ISO 1085 / ISO 10102 / ISO 3318
- Bocca inclinata a 15°
- Teste fresate
- Cromata opaca
- Cromo-vanadio

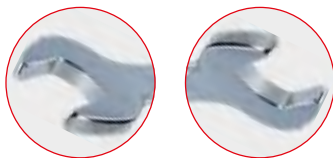

da **22,90**

<b>A</b>	517.0148			6x7 · 8x9 · 10x11 · 12x13 14x15 · 16x17 · 18x19 20x22 mm	22,90 €
<b>B</b>	517.0123			6x7 · 8x9 · 10x11 · 12x13 14x15 · 16x17 · 18x19 20x22 · 21x23 · 24x27 30x32 mm	49,90 €
<b>C</b>	517.0125			6x7 · 8x9 · 10x11 · 12x13 14x15 · 16x17 · 18x19 20x22 · 21x23 · 24x27 25x28 · 30x32 mm	54,90 €



- Profilo FlankTraction
- Bocca inclinata a 15°
- Anello piegato a 15°
- Teste lucidate
- Cromata opaca



da **25,90**

<b>A</b>	517.0048			8 · 9 · 10 · 11 · 13 · 14 17 · 19 mm	25,90 €
<b>B</b>	517.0052			8 · 9 · 10 · 11 · 12 · 13 · 14 15 · 16 · 17 · 18 · 19 mm	51,90 €
<b>C</b>	517.0043			6 · 7 · 8 · 9 · 10 · 11 · 12 13 · 14 · 15 · 16 · 17 · 18 19 · 20 · 21 · 22 · 24 · 27 30 · 32 mm	129,90 €



- Poligonale
- DIN 838 / ISO 1085 / ISO 10104 / ISO 3318
- Anelli piegati a 75°
- Sottili
- Teste lucidate



da **26,90**

<b>A</b>	517.0248			6x7 · 8x9 · 10x11 · 12x13 14x15 · 16x17 · 18x19 20x22 mm	26,90 €
<b>B</b>	517.0222			6x7 · 8x9 · 10x11 · 12x13 14x15 · 16x17 · 18x19 20x22 · 21x23 · 24x27 30x32 mm	54,90 €





**i** **1**  
Ulteriori informazioni

**19,90**

315 mm

22 mm

19 mm

522.1922

**i** **1**  
Ulteriori informazioni

**IL CRICCHETTO REVERSIBILE 4 IN 1**

10 mm

13 mm

17 mm

19 mm

**25,90**

72°

5°

503.4565

10 x 13 x 17 x 19 mm

**i** **1**  
Ulteriori informazioni

**IL MULTI-TALENTO**

Chiave manuale multifunzione

260 mm

8 - 17 mm

14 - 32 mm

114.0055

8 - 9 - 10 - 11 - 12 - 13 - 14 - 15 - 16 - 17 - 18 - 19 - 20 - 21 - 22 - 23 - 24 - 25 - 26 - 27 - 28 - 29 - 30 - 31 - 32 mm

**39,90**

**i** **12**  
Ulteriori informazioni

72°

5°

**149,90**

503.4665

8 - 9 - 10 - 11 - 12 - 13 - 14 - 15 - 16 - 17 - 18 - 19 mm

**i** **30**  
Ulteriori informazioni

**IL TUTTOFARE**

5/16" x 13 mm

1/2"

10 mm x 13 mm

3/8"

1/4" x 10 mm

1/4"

12 x

12 x

**179,90**

503.4960

8 - 9 - 10 - 11 - 12 - 13 - 14 - 15 - 16 - 17 - 18 - 19 mm



**i** **2**  
Ulteriori informazioni

**72**  $\times$  **5°**

**1/2"** **305 - 445 mm**

**1/4"** **173 - 223 mm**

**REGOLABILE:  
1/4" SU 4 LIVELLI  
1/2" SU 6 LIVELLI**

**NOVITÀ**

**42,90**

914.1412

**i** **1**  
Ulteriori informazioni

**NOVITÀ**

**600 MM!**

**72**  $\times$  **5°**

**1/2"** **460 - 600 mm**

Livello: **1 2 3 4 5 6**

**30,50**

**REGOLABILE IN 6 LIVELLI**

914.1205

**i** **1**  
Ulteriori informazioni

**53,90**

**760 mm**

**1/2"**

**MASSIMA FLESSIBILITÀ,  
CONTROLLO OTTIMALE**

918.1293

**72**  $\times$  **5°**

**POTENZA COSTANTE -  
FUNZIONE INNOVATIVA**

**A** **B** **C**

**1/4"** **3/8"** **1/2"**

**da 28,90**

			Nm		
<b>A</b>	920.1490		1/4"	102	140 mm 28,90 €
<b>B</b>	920.3890		3/8"	325	190 mm 31,90 €
<b>C</b>	920.1290		1/2"	710	245 mm 39,90 €

**102 Nm**

**710 Nm**

**72**  $\times$  **5°**

**NOVITÀ**

**62,90**

**920.0002** **i** **2**  
Ulteriori informazioni



# LA COSA MIGLIORE CHE ABBIAMO COSTRUITO!

Crediamo in quello che facciamo. Sappiamo qual è la qualità dei nostri nuovi cricchetti MONSTER, e ti offriamo la miglior garanzia su tutti i modelli. Non 2 o 3 anni. No, ben 10 anni! Una garanzia di prima qualità come i nostri cricchetti MONSTER!



**1** **80** <sup>4,5°</sup>  
**1/4"** **36,90**

**i** **1**  
Ulteriori informazioni

935.1490 **1/4"** **106 g** **125 mm** **>110 Nm**

**2** **80** <sup>4,5°</sup>  
**1/4"** **36,90**

**i** **1**  
Ulteriori informazioni

935.1495 **1/4"** **106 g** **125 mm** **>100 Nm**

**3** **96** <sup>3,75°</sup>  
**3/8"** **49,90**

**i** **1**  
Ulteriori informazioni

935.3890 **3/8"** **227 g** **199 mm** **>365 Nm**

**i**

**GARANTITO:  
6 MONSTER PER  
LA VITA!**

**4** **100** <sup>3,6°</sup>  
**1/2"** **59,90**

**i** **1**  
Ulteriori informazioni

935.1290 **1/2"** **567 g** **275 mm** **>950 Nm**

**5** **100** <sup>3,6°</sup>  
**1/2"** **79,90**

**i** **1**  
Ulteriori informazioni

935.1295 **1/2"** **757 g** **425 mm** **>950 Nm**

**6** **100** <sup>3,6°</sup>  
**1/2"** **119,90**

**i** **1**  
Ulteriori informazioni

**ALLUNGABILE IN MODO TELSCOPICO**

406 431 457 482 508 533 557 582 607 635 mm **>950 Nm**

935.1285 **1/2"** **1.280 g** **406 - 635 mm**

**NOVITÀ**

**-15%**

935.0002

**100** <sup>3,6°</sup>  
**1/2"** **>950 Nm**

**+**

**80** <sup>4,5°</sup>  
**1/4"** **>110 Nm**

**86,90**

**i** **2**  
Ulteriori informazioni





**Serie di bussole per viti a esagono incassato, corte**

3/8"

4 mm 5 mm 6 mm 7 mm 8 mm 9 mm 10 mm 12 mm 14 mm



917.4000 4 - 5 - 6 - 7 - 8 - 9 - 10 - 12 - 14 mm



NOVITÀ

**41,00**

**HO BISOGNO DI UN INSERTO, MA DEVE ESSERE CORTO!**



**Serie di bussole con inserto per viti Torx, corte**

3/8"

T10 T15 T20 T25 T27 T30 T40 T45 T50 T55



917.4015 T10 - T15 - T20 - T25 - T27 - T30 - T40 - T45 - T50 - T55

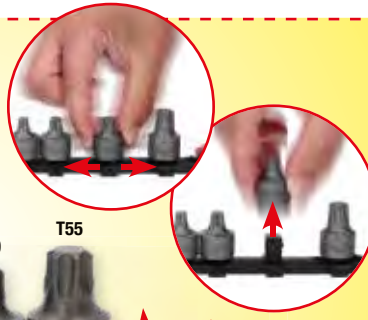

NOVITÀ

**51,90**

**TUTTO PER IL TORX IN UNA VALIGETTA**



5 x		1/4": E4 - E5 - E6 - E7 - E8
4 x		3/8": E10 - E12 - E14 - E16
4 x		1/2": E18 - E20 - E22 - E24
5 x		1/4": EPL4 - EPL5 - EPL6 - EPL7 - EPL8
4 x		3/8": EPL10 - EPL12 - EPL14 - EPL16
4 x		1/2": EPL18 - EPL20 - EPL22 - EPL24
8 x		1/4": T6 - T8 - T10 - T15 - T20 - T25 - T27 - T30
5 x		3/8": T40 - T45 - T47 - T50 - T55
2 x		1/2": T60 - T70
7 x		1/4": TB8 - TB10 - TB15 - TB20 - TB25 - TB27 - TB30
4 x		3/8": TB40 - TB45 - T50 - T55
1 x		1/2": TB60
7 x		1/4": IP8 - IP10 - IP15 - IP20 - IP25 - IP27 - IP30
3 x		3/8": IP40 - IP45 - IP50
2 x		1/2": IP55 - IP60
7 x		1/4": IPR8 - IPR10 - IPR15 - IPR20 - IPR25 - IPR27 - IPR30
3 x		3/8": IPR40 - IPR45 - IPR50
2 x		1/2": IPR55 - IPR60

- E ✓
- EPL ✓
- TX ✓
- TB ✓
- IP ✓
- IPR ✓

**109,00**

NOVITÀ



EVOLUTION SERIES

1/4" + 3/8" + 1/2"



911.0077

**i** **30**  
Ulteriori informazioni

**Evolution**  
SERIES

**NOVITÀ**

**89,90**

**1/2"**

**911.4510**

55 mm		5 - 6 - 7 - 8 - 10 - 12 - 14 - 17 - 19 mm
100 mm		5 - 6 - 7 - 8 - 10 - 11 - 12 - 13 mm
140 mm		5 - 6 - 7 - 8 - 10 - 12 - 14 mm
200 mm		5 - 6 - 7 - 8 - 10 - 12 mm

**STAINLESS STEEL**

**i** **32**  
Ulteriori informazioni

**Evolution**  
SERIES

**NOVITÀ**

**89,90**

**1/2"**

**911.4520**

55 mm		M5 - M6 - M7 - M8 - M9 - M10 - M12 - M13 - M14
100 mm		M5 - M6 - M7 - M8 - M9 - M10 - M12 - M13 - M14
140 mm		M7 - M8 - M9 - M10 - M12 - M13 - M14
200 mm		M7 - M8 - M9 - M10 - M12 - M13 - M14

**STAINLESS STEEL**

**i** **26**  
Ulteriori informazioni

**Evolution**  
SERIES

**NOVITÀ**

**89,90**

**1/2"**

**911.4540**

55 mm		M5 - M6 - M8 - M9 - M10 - M12 - M14 - M16
100 mm		M5 - M6 - M8 - M9 - M10 - M12 - M14
140 mm		M5 - M6 - M8 - M9 - M10 - M12 - M14
200 mm		M8 - M10 - M12 - M14

**STAINLESS STEEL**

**i** **32**  
Ulteriori informazioni

**Evolution**  
SERIES

**NOVITÀ**

**89,90**

**1/2"**

**911.4550**

55 mm		T20 - T25 - T27 - T30 - T40 - T45 - T50 - T55 - T60 - T70
100 mm		T20 - T25 - T27 - T30 - T40 - T45 - T50 - T55 - T60 - T70
140 mm		T40 - T45 - T50 - T55 - T60 - T70
200 mm		T40 - T45 - T50 - T55 - T60 - T70

**STAINLESS STEEL**



**A** Cromati opache      **B** Cromate lucide

da **36,90**

**A** 917.0648      48      36,90 €      1/4"      Nichelato

**B** 918.0648      48      39,90 €

4 - 4,5 - 5 - 5,5 - 6 - 7 - 8 - 9  
 10 - 11 - 12 - 13 - 14 mm

**i**           20           **Ulteriori informazioni**

**69,90**

Cromati opache

**1/2"**

10 - 11 - 12 - 13 - 14 - 15  
16 - 17 - 18 - 19 - 22 - 24  
27 - 30 - 32 mm

911.0620

**A** Cromati opache      **B** Cromate lucide

da **99,90**

**A** 911.0694      94      99,90 €      1/4" + 1/2"      Nichelato

**B** 918.0694      94      104,90 €

4 - 4,5 - 5 - 5,5 - 6 - 7 - 8 - 9  
 10 - 11 - 12 - 13 - 14 - 15 - 16  
 17 - 18 - 19 - 20 - 21 - 22 - 23  
 24 - 27 - 30 - 32 mm

**i**           108           **Ulteriori informazioni**

**109,00**

Cromati opache

**1/4" + 1/2"**

4 - 4,5 - 5 - 5,5 - 6 - 7 - 8 - 9  
 10 - 11 - 12 - 13 - 14 - 15 - 16  
 17 - 18 - 19 - 20 - 21 - 22 - 24  
 27 - 30 - 32 mm

911.0708





Ulteriori informazioni

1/4"	<ul style="list-style-type: none"> <li>4 - 4,5 - 5 - 5,5 - 6 - 7 - 8 - 9 - 10 - 11 - 12 - 13 - 14 mm</li> <li>4 - 5 - 6 - 7 - 8 - 9 - 10 mm</li> <li>E4 - E5 - E6 - E7 - E8</li> </ul>
3/8"	<ul style="list-style-type: none"> <li>10 - 11 - 12 - 13 - 14 - 15 - 16 - 17 - 18 - 19 mm</li> <li>10 - 11 - 12 - 13 - 14 - 15 mm</li> <li>E10 - E11 - E12 - E14 - E16 - E1</li> </ul>
1/2"	<ul style="list-style-type: none"> <li>10 - 11 - 12 - 13 - 14 - 15 - 16 - 17 - 18 - 19 - 20 - 21 - 22 - 24 - 27 - 30 - 32 mm</li> <li>16 - 17 - 18 - 19 - 22 mm</li> <li>E20 - E24</li> </ul>
1/4" 5/16"	<ul style="list-style-type: none"> <li>Standard hex bits</li> </ul>
1/4" - 3/8" 1/2"	<ul style="list-style-type: none"> <li>50 - 100 - 125 - 150 - 250 mm</li> <li>1,3 - 1,5 - 2 - 2,5 - 3 - 4 - 5 mm</li> </ul>
1/4" - 3/8" 1/2"	<ul style="list-style-type: none"> <li>1/4" - 5/16"</li> </ul>
1/4"	

1/4" + 3/8" + 1/2"

Nichelato

Cromata opaca



129,00

1/4"	<ul style="list-style-type: none"> <li>4 - 4,5 - 5 - 5,5 - 6 - 7 - 8 - 9 - 10 - 11 - 12 - 13 - 14 mm</li> <li>6 - 7 - 8 - 9 - 10 - 11 - 12 - 13 - 14 - 15 mm</li> </ul>
3/8"	<ul style="list-style-type: none"> <li>10 - 11 - 12 - 13 - 14 - 15 - 16 - 17 - 18 - 19 mm</li> <li>10 - 11 - 12 - 13 - 14 - 15 mm</li> </ul>
1/2"	<ul style="list-style-type: none"> <li>10 - 11 - 12 - 13 - 14 - 15 - 17 - 18 - 19 - 20 - 21 - 22 - 24 - 27 - 30 - 32 mm</li> <li>17 - 19 - 22 mm</li> </ul>
1/4" 5/16"	<ul style="list-style-type: none"> <li>Standard hex bits</li> </ul>
12 x	<ul style="list-style-type: none"> <li>8 - 9 - 10 - 11 - 12 - 13 - 14 - 15 - 16 - 17 - 18 - 19 mm</li> <li>1,3 - 1,5 - 2 - 2,5 - 3 - 4 - 5 mm</li> </ul>
1/4" - 3/8" 1/2"	
1/4"	



A Cromati opache

B Cromate lucide

A 917.0216



216

224,90 €

Nichelato

B 918.0216



216

229,00 €

1/4" + 3/8" + 1/2"

da 224,90





<b>A</b>	911.0721			21		19 · 21 · 22 · 23 · 24 · 26 · 27 · 29 · 30 32 · 35 · 36 · 38 · 41 · 46 · 50 mm	269, <sup>90</sup> €
<b>B</b>	911.0722			21		19 · 21 · 22 · 23 · 24 · 26 · 27 · 29 · 30 32 · 35 · 36 · 38 · 41 · 46 · 50 mm	309, <sup>00</sup> €
<b>C</b>	911.0751			21		3/4" · 13/16" · 7/8" · 15/16" · 1" 1.1/16" · 1.1/8" · 1.3/16" · 1.1/4" 1.5/16 · 1.3/8" · 1.7/16" · 1.1/2" 1.5/8" · 1.3/4" · 2"	295, <sup>00</sup> €

**da**  
**269,<sup>90</sup>**

			82
<b>Ulteriori informazioni</b>			
1/4"			4 - 4,5 - 5 - 5,5 - 6 - 7 - 8 - 9 - 10 - 11 12 - 13 - 14 mm
1/2"			14 - 15 - 16 - 17 - 18 - 19 - 20 - 21 - 22 24 - 27 - 30 - 32 mm
1/4"			16 - 21 mm
1/4"			
5/16"			
1/4"			
1/2"			
1/4"			150 mm
1/4"			50 - 100 - 125 - 250 mm
1/2"			
1/4"			150 mm
12 x			8 - 10 - 11 - 12 - 13 - 14 - 17 - 19 - 22 mm



**149,<sup>90</sup>**

911.0682

1/4" + 1/2"



**i**  **47**  
Ulteriori informazioni









1/2"		10 - 11 - 12 - 13 - 14 - 15 - 16 - 17 18 - 19 - 20 - 21 - 22 - 24 mm
3 x		16 - 18 - 21 mm
14 x		6 - 7 - 8 - 9 - 10 - 11 - 12 - 13 - 14 15 - 16 - 17 - 18 - 19 mm
1 x		250 mm
2 x		125 - 250 mm
1 x		1/2"
5 x		3 - 5,5 - 8 mm PH1 - PH2
1 x		T8 - T10 - T15 - T20 - T25 - T27 T30 - T40
1 x		2,5 - 3 - 4 - 5 - 6 - 7 - 8 - 10 mm
1 x		3 - 48 V
1 x		240 mm
1 x		180 mm
1 x		300 g



**179,90**

Cromata opaca





1/2" 

1/4"		4 - 4,5 - 5 - 5,5 - 6 - 7 - 8 - 9 - 10 11 - 12 - 13 mm
1/2"		10 - 11 - 12 - 13 - 14 - 15 - 16 - 17 19 - 20 - 21 - 22 - 24 - 27 - 30 - 32 mm
12 x		8 - 9 - 10 - 11 - 12 - 13 - 14 - 15 - 16 17 - 18 - 19 mm
2 x		1/4": 100 mm / 1/2": 125 mm
1 x		1/4" / 1/2"
7 x		3 - 4 - 5,5 - 6,5 mm PH0 - PH1 - PH2
1 x		T8 - T10 - T15 - T20 - T25 - T27 - T30 T40 - T45 - T50
1 x		1,5 - 2 - 2,5 - 3 - 4 - 5 - 6 - 8 - 10 mm
1 x		
1 x		300 g
1 x		160 mm
1 x		200 mm



1/4" + 1/2"

**A** Cromati opache **B** Cromate lucide

<b>A</b>	917.0797 	97 	209,90 €
<b>B</b>	918.0797 	97 	219,00 €

Nichelato



da **209,90**



**i** **88**  
Ulteriori informazioni

1/4"		4 - 4,5 - 5 - 5,5 - 6 - 7 - 8 - 9 - 10 - 11 12 - 13 mm
1/2"		14 - 15 - 16 - 17 - 18 - 19 - 20 - 21 - 22 23 - 24 - 25 - 26 - 27 - 28 30 - 32 mm
12 x		6 - 7 - 8 - 9 - 10 - 11 - 12 - 13 - 14 17 - 19 - 22 mm
3 x		1/4": 50 - 100 mm / 1/2": 125 mm
1 x		1/4"
4 x		6,5 - 8 mm + PH1 - PH2
1 x		1/4"
1 x		1/4"
1 x		150 - 250 V
1 x		250 mm
1 x		180 mm
1 x		300 g

199,<sup>90</sup>

Cromata opaca

911.0688

**1/4" + 1/2"**

**i** **127**  
Ulteriori informazioni

# IL TUTTOFARE

**1**

4 x

**2**

8 x 8 - 9 - 10 - 11 - 13  
14 - 17 - 19 mm

**3**

**4**

4 - 4,5 - 5 - 5,5 - 6 - 7  
8 - 9 - 10 - 11 - 12  
13 - 14 mm

1/4"

1/2"

10 - 13 - 14 - 16 - 17  
18 - 19 - 20 - 22 - 24  
27 - 30 - 32 mm

459,<sup>90</sup>

911.0727

**1/4" + 1/2"**





911.0649

1/4" + 1/2"

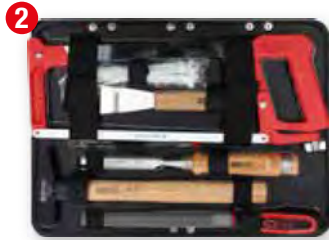

1/4"	4 - 4,5 - 5 - 5,5 - 6 - 7 8 - 9 - 10 - 11 - 12 13 mm
1/2"	10 - 13 - 14 - 15 - 16 17 - 18 - 19 - 21 - 22 24 - 27 - 30 - 32 mm
10 x	8 - 10 - 11 - 12 - 13 14 - 15 - 17 - 19 - 22 mm



**490,00**

**VUOI UN SET COMPLETO?  
PRENDI QUESTO!**



911.0630

1/4" + 1/2"



9 x	1,5 - 2 - 2,5 - 3 - 4 - 5 - 6 8 - 10 mm
9 x	TS10 - TS15 - TS20 - TS25 TS27 - TS30 - TS40 - TS45 TS50



1/4"	4 - 4,5 - 5 - 5,5 - 6 - 7 8 - 9 - 10 - 11 - 12 13 mm
1/2"	10 - 11 - 12 - 13 - 14 15 - 16 - 17 - 18 - 19 21 - 22 - 24 - 27 - 30 32 mm
11 x	8 - 9 - 10 - 11 - 12 13 - 14 - 16 - 17 - 19 22 mm



**575,00**





128

Ulteriori informazioni

# PER ELETTRICISTI

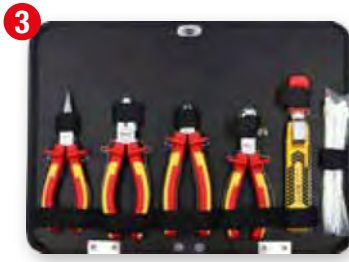

4 x

1/4" 4 - 4,5 - 5 - 5,5 - 6 - 7 - 8  
9 - 10 - 11 - 12 - 13 mm

1/2" 10 - 11 - 12 - 13 - 14 - 15  
16 - 17 - 18 - 19 - 21 - 22 mm

10 x 8 - 10 - 11 - 12 - 13 - 14  
15 - 17 - 19 - 22 mm

1/4" + 1/2"

911.0628

# 475,00



127

Ulteriori informazioni

# IL TUTTOFARE

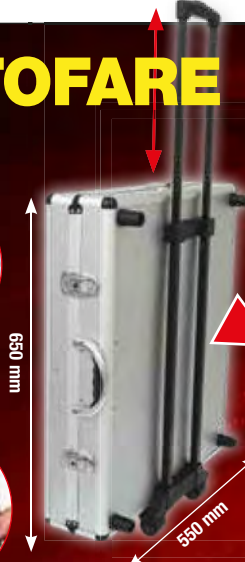

1/4" 4 - 5 - 6 - 7 - 8 - 9 - 11  
12 - 13 mm

1/2" 10 - 11 - 12 - 13 - 14 - 15 - 16  
17 - 18 - 19 - 21 - 22 - 24 mm

10 x 8 - 9 - 10 - 11 - 12 - 13  
14 - 16 - 17 - 18 - 19 mm

1/4" + 1/2"

911.0735

# 649,00





**i**  **99**  
Ulteriori informazioni

# UN TESORO!

**i**  **99**  
Ulteriori informazioni



	1/4"	4 - 5 - 6 - 7 - 8 - 9 - 10 - 11 - 12 13 - 14 mm
	1/2"	13 - 15 - 17 - 18 - 19 - 20 - 21 - 22 24 - 27 - 30 - 32 mm



**LA SCELTA È TUA!**

**CHIAVI A CRICCO COMBINATE**

**CHIAVI COMBINATE**

8 - 9 - 10 - 11 - 12 - 13 - 14 - 15 - 16 - 17 - 18 - 19 mm

8 - 9 - 10 - 11 - 12 - 13 - 14 - 15 - 16 - 17 - 18 - 19 mm



**669,90**

**579,90**

1/4" 1/2"

1/4" 1/2"



918.0100 

918.0200 

**i**  **40**  
Ulteriori informazioni

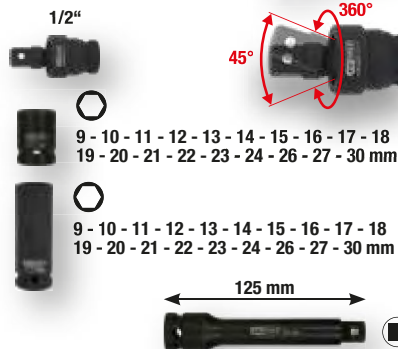

**139,90**

1/2"

515.0065





Ulteriori informazioni





1











**da**  
**119,90**



Scala con lente di ingrandimento



Scala micrometrica



con certificazione  
DIN EN 550 6789  
Certificazioni  
Precisione

		Nm	Suddivisione Nm	Lbf-ft		
516.1402		1/4"	1-5	0,10	0,8 - 3,6	119,90 €
516.1412		1/4"	5-25	0,10	0,8 - 18	119,90 €
516.1422		3/8"	10-50	0,25	4 - 37	125,90 €
516.1432		1/2"	20-100	0,50	8 - 75	139,90 €
516.1442		1/2"	40-200	1,00	15 - 150	139,90 €
516.1472		1/2"	60-320	1,00	45 - 236	159,90 €
516.1482		1/2"	80-420	1,00	60 - 310	179,90 €
516.1493		3/4"	150-750	10,00	150 - 550	699,90 €
516.1495		1"	200-1000	20,00	220 - 730	799,90 €

**3 IN 1**



1



2



3



A



B

**LUNGO**

**11,90**

A	151.2100		8		2 - 2,5 - 3 - 4 - 5 - 6 8 - 10 mm	11,90 €
B	151.2300		8		T10 - T15 - T20 - T25 T30 - T40 - T45 - T50	11,90 €



Ulteriori informazioni





22





**LUNGO**

**15,90**





1-27 - 1,5 - 2 - 2,5 - 3 - 3,5 - 4 - 4,5 - 5 - 6 - 7 - 8 - 10 mm





T10 - T15 - T20 - T25 - T27 - T30 T40 - T45 - T50

**I 22 PZ PIÙ IMPORTANTI  
IN UN'UNICA SERIE**

151.4000



**32**  
Ulteriori informazioni

**Nichelato**

1 x		1/4"
1 x		1/4"
3 x		PH1 - PH2 - PH3
6 x		2 x PZ1 - 2 x PZ2 - 2 x PZ3
3 x		5,5 - 6,5 - 8 mm
3 x		4 - 5 - 6 mm
15 x		2 x TB10 - 3 x TB15 - 2 x TB20 3 x TB25 - 3 x TB30 - 2 x TB40

911.2060

**32**  
Ulteriori informazioni

**TORION power**

+30%

1 x		1/4"
1 x		1/4"
4 x		3 - 4 - 5 - 6 mm
4 x		PH1 - 2 x PH2 - PH3
4 x		PZ1 - 2 x PZ2 - PZ3
4 x		3 - 4 - 5 - 6 mm
7 x		T10 - T15 - T20 - T25 - T27 - T30 - T40
7 x		TB10 - TB15 - TB20 - TB25 - TB27 - TB30 - TB40

911.3030

11,90

**108**  
Ulteriori informazioni

**TORION power**

25 mm

- 6x: 4 - 5 - 6 mm
- 6x: 4 - 5 - 6 mm
- 6x: PH1 - PH2 - PH3
- 6x: PZ1 - PZ2 - PZ3
- 6x: T10 - T15 - T20 - T25 - T30 - T40

918.3108

**37,00**

**NOVITÀ**

**+30%**

108 INSERTI CHE FANNO LA DIFFERENZA

**32**  
Ulteriori informazioni

68 mm

100 mm

4 x		3 - 4 - 5 - 6 mm
4 x		PH1 - 2 x PH2 - PH3
4 x		PZ1 - 2 x PZ2 - PZ3
4 x		3 - 4 - 5 - 6 mm
7 x		T10 - T15 - T20 - T25 T27 - T30 - T40
7 x		TB10 - TB15 - TB20 - TB25 TB27 - TB30 - TB40

918.3010

**48,90**

-22,1%

-49%

**31**  
Ulteriori informazioni

**TORION power**

2 x		4 - 5 mm
3 x		PH1 - PH2 - PH3
3 x		PZ1 - PZ2 - PZ3
9 x		1,5 - 2 - 2,5 - 3 - 4 - 5 - 6 7 - 8 mm
11 x		T6 - T7 - T8 - T9 - T10 - T15 T20 - T25 - T27 - T30 - T40

918.3015

**67,90**



**i** **24**  
Ulteriori informazioni

**PICCOLO & MIGLIORE**

25 mm  
Nichelato

**25,00**

1 x		1/4": 92 mm
1 x		1/4": 50 mm
1 x		1/4"
6 x		6 - 7 - 8 - 10 - 11 - 13 mm
2 x		PH1 - PH2
2 x		PZ1 - PZ2
2 x		4,5 - 5,5 mm
4 x		3 - 4 - 5 - 6 mm
5 x		TB10 - TB15 - TB20 - TB25 - TB30

911.2010 **1/4"**

**i** **208**  
Ulteriori informazioni

**49,90**

**L'AVVITATUTTO!**

1/4"		1/4": 205 mm
138 x		25 mm
29 x		50 mm
18 x		75 mm
20 x		4 - 5 - 6 - 7 - 8 - 9 - 10 - 11 - 12 - 13 mm 5/32" - 3/16" - 7/32" - 1/4" - 9/32" 5/16" - 11/32" - 3/8" - 7/16" - 1/2"
1 x		1/4": 50 mm
1 x		1/4"

911.2008 **1/4"**

**i** **7**  
Ulteriori informazioni

**UN'INNOVAZIONE NELLA TECNICA!**

**13,90**

**6 IN ONE**

**NOVITÀ**

- 4 - 5 mm
- PH1 - PH2
- PZ1 - PZ2

110 mm

**1/4"**

159.2025 **6 in 1 portainseriti a cricchetto corto**

**i** **13**  
Ulteriori informazioni

**17,90**

**12 IN ONE**

- 4 - 5 - 6 mm
- PH1 - PH2 - PH3
- 3 - 4 - 5 mm
- T15 - T20 - T25

240 mm

**1/4"**

159.2035 **12 in 1 Giravite a cricco per inserti**



**1**  
Ulteriori informazioni

**2 IN 1**

1/4"

85 mm

**9,90**

**1**  
Ulteriori informazioni

1/4"

**12,90**

**CON SNODO**

90 mm

20°

**21**  
Ulteriori informazioni

4 mm

30 mm

165 mm

Ø 16 mm

**49,00**

1 - 1,3 - 1,5 - 2 - 2,5 - 3 mm

PH00 - PH0 - PH1 - PH2

1,5 - 2 - 2,5 - 3 - 3,5 mm

T3 - T4 - T5 - T6 - T7

**27**  
Ulteriori informazioni

LED

1/4"

**45,90**

**PROVAMI, RIMARRAI SEDOTTO PER SEMPRE.**

**MAX**

max 6 Nm

**MAX**

max 4 Nm

**MAX**

max 2 Nm

4x		3,0 - 4,0 - 5,0 - 6,0 mm
4x		3,0 - 4,0 - 5,0 - 6,0 mm
5x		PH0 - PH1 - PH2 - PH3
4x		PZ0 - PZ1 - PZ2 - PZ3
4x		T10 - T15 - T20 - T25
4x		#0 - #1 - #2 - #3
1x		PH1
1x		50 mm
1x		Max. 6 Nm

3,6 V

1.500 mAh

300 rpm

USB-C

2+ LED





Ulteriori informazioni

# IL TUTTOFARE



## 1 Forare



## 2 Pulire



## 3 Levigare



## 4 Incidere

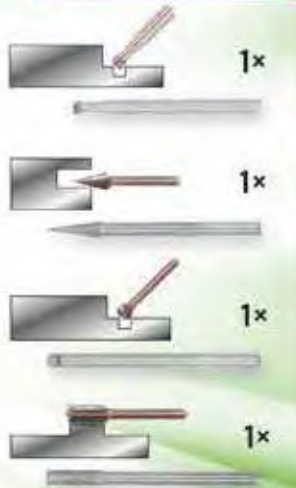

## 5 Taglio



## 6 Lucidare



**eMONSTER**  
Set utensile multifunzione  
a batteria ricaricabile  
con 50 accessori



# eMONSTER



# 59,90

515.3990



Ulteriori informazioni

## DA ACQUISTARE SUCCESSIVAMENTE



Serie di accessori, 50 pz

# 12,90

515.3992



# LA RIVOLUZIONE TRA I CACCIAVITI



**e MONSTER**

210 giri/min di  
velocità massima,  
5 volte più veloce  
rispetto al  
serraggio  
manuale

Pratico indicatore del  
livello di carica della  
batteria con 3 LED

Ingranaggio  
rinforzato



2 in 1 con un rapporto eccellente tra potenza e dimensione,  
l'ideale per lavorare in posizioni scomode e strette.

Portainseri  
magnetico



Preselezione coppia  
regolabile su 10 livelli



Luce integrata



Migliore comfort  
della presa



Batteria  
da 1.3 Ah,  
durata utile:  
circa  
**1000+**  
viti

La batteria agli ioni di Li si  
ricarica velocemente grazie alla  
presa USB-C, ed è subito pronto  
per l'uso



Al superamento della coppia di  
serraggio il motore si blocca evitando  
di stringere troppo e rompere il filetto  
della vite.



Ulteriori informazioni

25 inserti  
inclusi



**49,90**



515.6500



# ERGOTORQUE<sup>plus</sup>

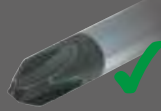

Cromati con punta brunita



Impugnatura marcata con il profilo

**i** **5** **159.0005**

Ulteriori informazioni

**15,90**

PH1 PH2 6,5 mm 5,5 mm 4 mm

**i** **6** **159.0030**

Ulteriori informazioni

**25,90**

T10 T15 T20 T25 T30 T40

**i** **6** **159.0040**

Ulteriori informazioni

**25,90**

TB10 TB15 TB20 TB25 TB30 TB40

**i** **39**

Ulteriori informazioni

**59,90**

6 x		3 - 4 - 5,5 - 6,5 8 - 10 mm	7 x		2 - 2,5 - 3 - 4 - 5 6 - 8 mm
5 x		PH0 - PH1 - PH2 PH3 - PH4	7 x		TB10 - TB15 - TB20 TB25 - TB27 - TB30 TB40
4 x		PZ0 - PZ1 - PZ2 PZ3	7 x		T10 - T15 - T20 T25 - T27 - T30 T40
1 x		6 mm	1 x		1/4"
1 x		PH2	1 x		205 mm

**159.0100** **1/4"**

**i** **13**

Ulteriori informazioni

**RESISTENTE AGLI URTI!**

**79,90**

Lama passante

5 x		3,5 - 5,5 - 7 - 8 - 10 mm
5 x		PH0 - PH1 - PH2 - PH3 - PH4
1 x		6 mm
1 x		PH2
1 x		1/4"

**151.1150** **1/4"**



**i**  **15**  
Ulteriori informazioni

260 mm



**A**

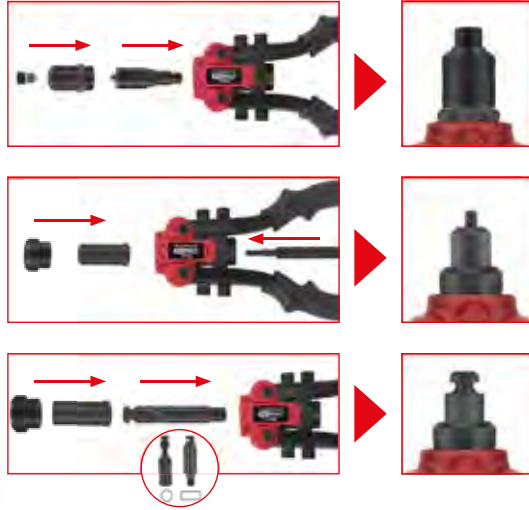

**82,90**

150.9805







Rivetti (alluminio)



Rivetti (acciaio)



Dado

		<b>A</b>	<b>B</b>
		150.9805	150.9630
	in valigetta	✓	✓
	lunghezza mm	260	510
	cesoia roditrice	✓	✗
	azionamento con una o due mani		
	M10	✓	✓
	M8	✓	✓
	M6	✓	✓
	M5	✓	✓
	M4	✓	✓
	M3	✓	✓
	Acciaio 4,8 mm	✓	✓
	Acciaio 4,0 mm	✓	✓
	Acciaio 3,2 mm	✓	✓
	Acciaio 2,4 mm	✓	✓
	Alluminio 6,4 mm	✓	✓
	Alluminio 4,8 mm	✓	✓
	Alluminio 4,0 mm	✓	✓
	Alluminio 3,2 mm	✓	✓
	Alluminio 2,4 mm	✓	✓

**i**  **17**  
Ulteriori informazioni

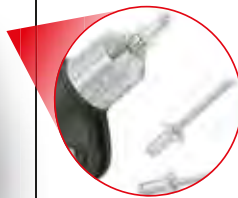

**B**

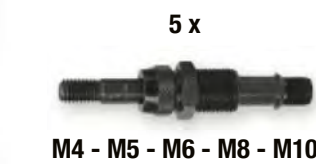
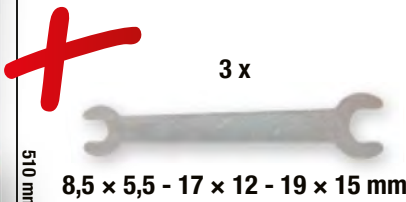

**184,90**

150.9630



**i** **1**  
Ulteriori informazioni

**da 14,90**

35 - 90 mm

	↔	↔	
115.2011	175 mm	7"	14,90 €
115.2010	240 mm	10"	16,90 €
115.2012	300 mm	12"	21,90 €
115.2016	415 mm	16"	38,90 €

**i** **4**  
Ulteriori informazioni

CrV DIN 5254 A DIN 5254 B DIN 5256 C DIN 5256 D

**QUALITÀ ECCEZIONALE!**

**i** **4**  
Ulteriori informazioni

**A** 19 - 60 mm

**B** 40 - 100 mm

**da 119,90**

	↺ ↻	↔		
<b>A</b>	119.2055	19 - 60 mm	160 mm	119,90 €
<b>B</b>	119.2060	40 - 100 mm	230 mm	129,90 €

**i** **20**  
Ulteriori informazioni

**LA SICUREZZA PRIMA DI TUTTO**

60 - 100 mm

40 - 85 mm

**55,90**

0° 15° 45° 90°

90° 45° 15° 0°

500.1350 Serie di pinze per anelli Seeger con cricchetto



# UTENSILI DI PRECISIONE SORPRENDENTI!

**i** **10**  
Ulteriori informazioni

**32,90**

260 mm

300 mm

500.7220

1 x		120 mm	1 x		160 mm
1 x		120 mm	3 x		PH00 - PH0 - PH1
1 x		120 mm	3 x		2,0 - 2,4 - 3,0 mm

ESD

**i** **21**  
Ulteriori informazioni

**119,90**

430 mm

370 mm

500.7190

2 x		125 - 130 mm	3 x		PH00 - PH0 - PH1
1 x		100 mm	4 x		1,4 - 2,0 - 2,4 - 3,0 mm
1 x		100 mm	7 x		T6 - T7 - T8 - T9 - T10 - T15 - T20
1 x		125 mm			
1 x		150 mm			
1 x		145 mm			

**i** **1**  
Ulteriori informazioni

500g

Con perno di regolazione stabile, simile a una punta per tracciare

Ø 8,0 mm

150 - 675 mm

**6,90**

Con una testa magnetica rigida

2in1 Supporto magnetico telescopico con ugelli di lavaggio e utensile di messa in fase

550.1001

**i** **1**  
Ulteriori informazioni

2,5 kg

Con bacchetta di pulizia sottile

Ø 11,0 mm

150 - 590 mm

**9,90**

Testa magnetica flessibile

2in1 Supporto magnetico telescopico con ugelli di lavaggio e utensile di messa in fase

550.1023

**i** **1**  
Ulteriori informazioni

**11,90**

260 - 760 mm

max. 60 h

1 x CR 2032

LED

50 x 80 mm

Specchio di ispezione flessibile con illuminazione

550.1136

**i** **5**  
Ulteriori informazioni

3 x LR44

NOVITÀ

**20,90**

5 IN 1

3,6 kg

Ø 52,0 mm

Ø 31,0 mm

90,0 x 50,0 mm

172 - 640 mm

550.1145

Con bloccaggio rapido



**i** **4**  
Ulteriori informazioni

**11,90**

45° 135° 0° 90°

550.1045

**i** **9**  
Ulteriori informazioni

**22,90**

45° 135° 0° 90° 45° 90° 0°

550.1070

**i** **1**  
Ulteriori informazioni

**12,90**

Piezo

115 mm

960.1110

**i** **1**  
Ulteriori informazioni

**21,90**

300 mm

550.1060

**i** **8**  
Ulteriori informazioni

**25,00**

95 mm

Ø 40 mm

49 mm

5 mm 1,6 mm 3,5 mm 4,5 mm

960.1265

**i** **11**  
Ulteriori informazioni

**37,90**

Piezo

200 mm

20 mm 33 mm 1,6 mm 3,5 mm 4,5 mm 5 mm 30 mm

95 mm 95 mm

Ø 40 mm

ISO BUTAN

960.1160 Set micro-saldatura



**i** **283**  
Ulteriori informazioni

**199,90**

220 mm

Ø 0,5 - 6 mm    Ø 0,5 - 6 mm

Ø 0,5 - 10 mm    Ø 6,50 / 5,41 / 1,72 mm    Ø 0,5 - 4 mm

Ø 1,0 - 3,2 mm

115.1400

**i** **1**  
Ulteriori informazioni

**5,90**

143 mm

118.0013

**i** **1**  
Ulteriori informazioni

**da 4,90**

EG II

A 16 mm    B 19 mm    C 25 mm    D 25 mm

	300.0113	300.0114	300.0115	300.0116
A	3 m	5 m	5 m	8 m
B	16 mm	19 mm	25 mm	25 mm
C	4,90 €	5,90 €	6,90 €	7,90 €
D				

118.0013

**i** **5**  
Ulteriori informazioni

regolazione temperatura  
1≈50°C / 2≈100°C / 3≈200°C /  
4≈350°C / 5≈550°C / 6≈650°C

260 mm

1 2 3 4 5 6

1 max. 450°C  
2 max. 650°C

**39,90**

960.1190

Campi di applicazione: Rimozione di colore, saldature di tubi, riduzioni di PVC, saldature, curvature di plastica, asciugature, scongelamenti, ecc.

**i** **1**  
Ulteriori informazioni

**IP 34**

15+1 m

3x 1,5 mm²

230 V 50 Hz

1000/3000 W

10 A

**159,90**

150.4217

**i** **12**  
Ulteriori informazioni

**12,90**

145 mm

5,0 x 1,0 mm  
5,0 x 1,0 mm  
3,0 mm  
3,0 mm  
5,0 mm  
5,0 mm  
3,0 mm  
2,0 mm  
2,0 mm  
5,0 mm  
5,0 mm  
5,0 mm

140.3050

**i** **5**  
Ulteriori informazioni

**37,90**

200 mm

140.3000



**i** **1**

Ulteriori informazioni

**27,90**

138 x 69 x 31 mm

342

9 V

Data Hold

69 mm

138 mm

150.1495

**i** **1**

Ulteriori informazioni

3 - 48 V

140 mm

**12,90**

550.1503

Tester di polarità e cercafase 3 - 48 V

**i** **1**

Ulteriori informazioni

125 mm

6 - 24 V

**5,90**

550.1504

Tester luminoso 6 - 24 V

**i** **1**

Ulteriori informazioni

**AUTOMATIC**  
DIGITAL MULTIMETER

143 x 70 x 16 mm

119

AAA

Data Hold

16 mm

143 mm

70 mm

**59,90**

150.1765

NCV

USB-A

USB-C

**N. Descrizione**

- 1 Pulsante ON/OFF
- 2 Interruttore funzioni
- 3 Interruttore capacità
- 4 Interruttore illuminazione
- 5 Display LCD
- 6 Campo sensore NCV
- 7 Cavi di misurazione

Simboli	Spiegazione
	Tensione continua
	Tensione alternata
	Visualizzazione per la funzione di spegnimento automatico
	Visualizzazione per il livello della batteria basso
	Modalità diodo
	Continuità
	Capacità
	Rapporto di misurazione della potenza
<b>HOLD</b>	Funzione di memorizzazione
<b>V, mV</b>	Unità di misura della tensione: volt, millivolt
<b>mF, µF, nF</b>	Unità di misura della capacità
<b>MΩ, KΩ, Ω</b>	Unità di misura della resistenza
<b>NCV</b>	Induzione di tensione senza contatto
<b>Live</b>	Controllo cavi che conducono tensione
<b>KHz, Hz</b>	Unità della frequenza
<b>°C/°F</b>	Celsius/Fahrenheit

3 COLOUR ANALOG BAR

BUZZER ALARM



**i** **3**  
Ulteriori informazioni

210 x 88 x 44 mm  
655  
9 V  
Data Hold

**39,90**

27,0 mm

Max. diametro misurabile del conduttore 29,0 mm

150.0925

**i** **1**  
Ulteriori informazioni

Per tensione continua e alternata

AC	6 - 50 - 120 - 230 - 400 V
DC	6 - 50 - 120 - 230 - 400 V

**25,90**

550.1501

## CHIAVE UNIVERSALE PER QUADRI ELETTRICI AD ARMADIO

**i** **1**  
Ulteriori informazioni

**MINI**

42 mm

- 6 - 7 - 8 mm
- 9 mm
- 3 - 5 mm
- PH 2
- 7 mm

**19,90**

130.1010

**i** **1**  
Ulteriori informazioni

71 mm

- 6 - 7 - 8 mm
- 9 mm
- 3 - 5 mm
- PH 2
- 7 mm

**19,90**

130.1015

**i** **1**  
Ulteriori informazioni

61 mm

- 5 - 7 - 8 mm
- 9 - 10 mm
- 4 - 10 mm
- PH 2
- 7 mm

**19,90**

130.1020

**Cavetto di guida per cavi**

10 metri    20 metri

**da 6,90**

<b>A</b>	150.0960		<b>1</b>	Ø 3,0 mm 10 m	<b>6,90 €</b>
<b>B</b>	150.0970		<b>1</b>	Ø 4,0 mm 20 m	<b>11,90 €</b>

**i** **1**  
Ulteriori informazioni

**36,90**

Ø 3,0 mm

30 metri

**Ausilio inserimento cavo**

115.1113



**i** **1**  
Ulteriori informazioni

**26,<sup>90</sup>**

- Con regolazione rapida
- Barra di misurazione in mm e in pollici
- Con tabella per filettature

300.0510

**i** **1**  
Ulteriori informazioni

**31,<sup>90</sup>**

+/- 0,03 mm

- Con vite di fermo e rotellina di regolazione
- Per misurazioni di esterni, interni, cavità e profondità

300.0532

**i** **1**  
Ulteriori informazioni

**TERMOMETRO  
A RAGGI INFRAROSSI,  
-38° - 520°**

**59,<sup>90</sup>**

150.3040

**i** **4**  
Ulteriori informazioni

**67,<sup>90</sup>**

550.1290

Rifrattometro - strumento ottico per il controllo del liquido batterie e del liquido antigelo

**i** **4**  
Ulteriori informazioni

**79,<sup>90</sup>**

550.1285

Rifrattometro - strumento ottico per il controllo del liquido batterie, del liquido antigelo e dell'additivo AdBlue®



**i** **4**  
Ulteriori informazioni

**25,90**

11 x 115 mm  
15 x 185 mm  
18 x 320 mm  
18 x 470 mm

**Serie di leve con estremità piatta**

911.8100

**i** **4**  
Ulteriori informazioni

**XL**

900 mm  
600 mm

0°  
45°  
75°  
90°

**179,90**

**Serie di leve con estremità piatta**

911.8410

**i** **22**  
Ulteriori informazioni

**Serie di estrattori universali idraulici a 2 + 3 bracci**

- Slittamento minimo grazie ai bracci autoserranti
- 8 possibili varianti di estrazione
- Vite di pressione estremamente robusta con filettatura temprata a induzione
- Sforzo minimo
- Acciaio speciale per utensili

**339,90**

700.1200

10 t, AG 1.1/2" x 16G

20 - 35 - 85 mm  
235 mm  
185 mm

225 mm  
170 mm  
120 mm

Ø max. 100 mm

**TO1**

**i** **13**  
Ulteriori informazioni

**NOVITÀ**

**PER CASI DI EMERGENZA**

**84,90**

0% ✓ 85% ✓

Per la rimozione di viti e dadi bloccati, rovinati o arrotondati **fino all'85%**

**84,90**

Compresi 3/8" 1/2"

8 - 9 - 10 - 11 - 12 - 13 - 14 - 15 - 16 - 17 - 18 - 19 mm **3/8"**

913.3930

**i** **7**  
Ulteriori informazioni

**96,90**

Anelli piegati a 45°

6x7 - 8x9 - 10x11 - 12x13 - 14x15 - 16x17 - 18x19 mm

517.1555



SONO UNA VITE, SVITAMI!



Ulteriori informazioni

- Per viti da M3 - M18
- Permette lo svitamento di viti e perni logorati
- Elica conica
- In robusta scatola di plastica



150.1330 Serie di estrattori per viti

19,90

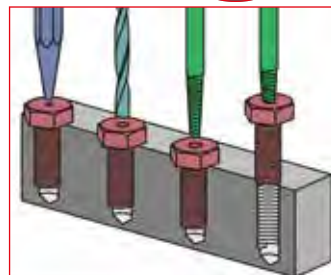

Ulteriori informazioni

TORION power

54,90

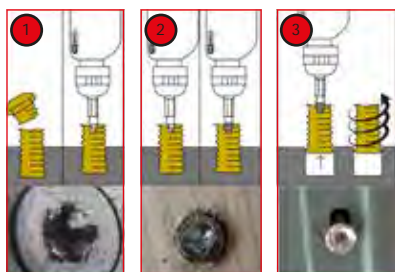

9 x		TE10 - TE15 - TE20 - TE25 - TE27 - TE30 - TE40 - TE50 - TE55
9 x		1,5 - 2 - 2,5 - 3 - 4 - 5 - 6 - 8 - 10 mm
7 x		1,5 - 2 - 2,5 - 3 - 4 - 5 - 6 mm
7 x		T10 - T15 - T20 - T25 - T27 - T30 - T40



150.7060 1/4" + 10 mm Kit estrazione con viti speciali



Ulteriori informazioni

Serie di estrattori

- Assortimento completo
- Per rimuovere tiranti filettati e viti rotte
- Nessun danneggiamento del filetto
- Lieve allargamento del tirante filettato grazie alla punta per estrattore con profilo speciale

Führungshülse drill guide	Hülse Innen- Ø mm guide	vorböhren Ø mm pre-drilling	aufbohren re-drilling	Stift pin	Art.Nr. Stift No. Pin	Mutter D nut D	Art.Nr. Mutter nut D	Stift + Mutter pin + nut
150.0501	4,0 / 3,2	3,2	-	3,2	150.0521	SW 10	150.0511	150.0511S
150.0502	4,8 / 3,2	3,2	-	3,2	150.0521	SW 10	150.0511	150.0511S
150.0503	4,8 / 3,2	3,2	4,8	4,8	150.0522	SW 11	150.0512	150.0512S
150.0504	4,8 / 3,2	3,2	4,8	4,8	150.0522	SW 11	150.0512	150.0512S
150.0505	6,0 / 4,8	4,8	6,4	6,4	150.0523	SW 13	150.0513	150.0513S
150.0506	7,0 / 4,8	4,8	6,4	6,4	150.0523	SW 13	150.0513	150.0513S
150.0507	7,0 / 4,8	4,8	8,0	8,0	150.0524	SW 14	150.0514	150.0514S
150.0508	7,0 / 4,8	4,8	8,7	8,7	150.0525	SW 17	150.0515	150.0515S
150.0509	9,0 / 6,5	6,4	8,7	8,7	150.0525	SW 17	150.0515	150.0515S
150.0510	9,5 / 6,5	6,4	8,7	8,7	150.0525	SW 17	150.0515	150.0515S



150.1305 M5 - M6 - M8 - M10 - M12 - M14 - M16

49,90

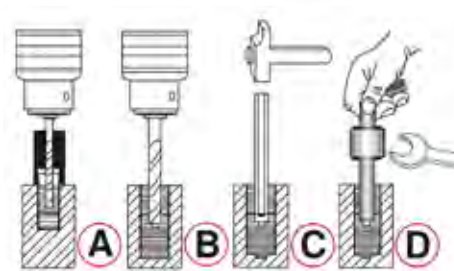





Ulteriori informazioni

### Serie di estrattori per prigionieri

- Attacco esagonale 21,0 mm
- Con funzione di serraggio a destra e a sinistra
- Tenuta sicura grazie ai 3 rulli
- Per avvitare e svitare senza complicati serraggi di un secondo dado sul bullone
- Adatto anche per prigionieri molto lunghi - poiché ha un foro per tutta la loro lunghezza

# 55,90



152.1101 M5 - M6 - M7 - M8 - M10 - M12 - M14



Ulteriori informazioni

### Serie di utensili per filettare in HSS Co in cassetta per uso industriale

- Assortimento universale
- Maschio a mano scanalato dritto
- Con giramaschi regolabile e girafilere
- In dotazione contafiletti e giraviti
- Acciaio HSS ad alte prestazioni al cobalto



## NON MANCA NULLA



33 x		M3 - M4 - M5 - M6 - M8 - M10 - M12 M14 - M15 - M18 - M20
11 x		M3 - M4 - M5 - M6 - M8 - M10 - M12 M14 - M15 - M18 - M20
6 x		M3-M4 - M4,5-M6 - M7-M9 - M10-M11 - M12-M14 - M16-M20
2 x		M1-M10 - M5-M20

# 559,00

331.0754



Ulteriori informazioni

### A TUTTI PIACE INDOSSARLO!

# 29,90



EN388



4131X

maglia superfine

	Formato	Unità di imballaggio
310.0490	7	12 paia
310.0491	8	12 paia
310.0470	9	12 paia
310.0475	10	12 paia
310.0480	11	12 paia



Ulteriori informazioni

# 5,90



310.0120



**MODELLO FLAME**

Ulteriori informazioni

**59,90**

310.0155

**MODELLO STEEL**

Ulteriori informazioni

**59,90**

310.0195

**Dati tecnici:**

Assortimento colori:	A regolazione continua da DIN 9-13 Impostazione standard della luce: DIN 4
Tempi di reazione della commutazione:	1/25.000 s
Protezione da UV/IR:	Secondo norme EN169 /fino a DIN 16
Temperatura di esercizio:	da -5°C fino +55°C
Temperatura di stoccaggio:	da -20°C fino +70°C
Alimentazione:	solare
Altezza:	220 mm
Larghezza:	200 mm
Lunghezza:	295 mm
Peso:	480 g
Misure cassetta:	110 x 90 x 9 mm
Vetrino visore:	92 x 42 mm

**Nebulizzatore a pressione universale**

Ulteriori informazioni

- In pregiato polietilene
- Per diverse sostanze chimiche, per es. detersivi, solventi, ecc.
- Non adatto al detersivo freni
- Testina spray in ottone regolabile e chiudibile
- Guarnizioni in Viton®
- Adatto per lavori in alto

**Non adatto al detersivo freni**

**da 17,90**

150.8251	1 L	17,90 €
150.8252	2 L	21,90 €

310.0155

**0,25 L**

Ulteriori informazioni

**NOVITÀ**

**Specifico per detersivo freni**

**60,90**

Aluminium

150.8272



**16**  
Evolution  
SERIES

Ulteriori informazioni

**Raschietto per vetro**

- Ideale per la rimozione di adesivi, residui di colla e di guarnizioni
- Agevole sostituzione delle lame svitando la vite a testa zigrinata posta sul mandrino di serraggio.
- Pratico sistema di custodia con vani estraibili per le diverse forme di lama.
- Ideale per diversi campi di applicazione grazie alle diverse lame
- Raschietto in materiale bicomponente

Lame di ricambio: 907.2202, 907.2203, 907.2204, 907.2205, 907.2206

**NOVITÀ**

5x 12 mm  
5x 16 mm  
5x 20 mm

145 mm

**18,90**

907.2255

**27**  
Ulteriori informazioni

**Serie di coltelli e raschietti**

5x 19 mm  
145 mm

5x 12 mm  
5x 16 mm  
5x 16 mm  
5x 20 mm

145 mm

**24,90**

907.2200

**Raschietto a lame intercambiabili**

A 110 mm  
B 145 mm

da **5,90**

A	907.2240	1	110 x 39 mm	5,90 €
B	907.2242	1	145 x 40 mm	6,90 €

**Coltellino pieghevole con fermo**

A 190 mm  
B 220 mm

da **14,90**

A	907.2105	1	190 x 25 mm	14,90 €
B	907.2190	1	220 x 28 mm	14,90 €

**2**  
Ulteriori informazioni

155 mm  
97 mm

**19,90**

907.2172

**Serie di coltelli a serramanico**

**3**  
Ulteriori informazioni

250 mm

**46,90**

118.0050

**Serie di cesoie a doppia leva per lamiere**



**5** Serie videoscopio Wi-Fi-con sonda fotocamera anteriore Ø 5,5 mm 0° HD

Ulteriori informazioni

**HD**

Wi-Fi

Ø 5,5 mm

Ø 5,5 mm

IP68

3500 mm

**52,90**

550.7560

**EXTEND YOUR EYE**

da **279,90**

Testa custodia videocamera in acciaio inox  
Attacco filettato per sonda

Design a corona (ottimale sia per la protezione che per la pulizia)

Videocamera

Lenti

LED

Testa videocamera con filetto esterno

Vetro zaffiro

Ø 6,0 mm

Ø 4,5 mm

1500 mAh Li-polymer

0 / 90°

PUSH 0 / 90°

1000 mm

Cavo di connessione

3,5"

USB 2.0

microSD

**HD**

6 mini-LED con regolazione della luminosità

0° 90°

Ø

**A** 550.7500 **5** 6,0 mm 0° + 90° 279,90 €

**B** 550.7530 **7** 4,5 mm 0° + 90° 339,90 €

1000 mm

50 mm

**IP 67**

AVI 1280 x 720

JPG

150 mm

-10°/+60°C

**A** Magnete

**B** Magnete

Gancio





**i**  **3**  
Ulteriori informazioni

  
**Ø**  
**3,9 mm**

6 mini-LED con regolazione della luminosità

**1000 mm**  
**90 mm**

**0°**  
**Controllabile**  
**180°** **180°**

**Ruotabile**  
**Ruotabile**  
**360°**

Cavo di connessione

  
USB 2.0  
  
microSD

  
3000 mAh  
Li-polymer

**IP**  
**67**

**AVI**  
1280 x 720

**JPG**

**150 mm**

**-10°/+60°C**

**NOVITÀ**

**469,<sup>90</sup>**

**+ 32 GB**

**550.7550** Serie videoscopi HD con sonda telecamera frontale  
HD Ø 3,9 mm 180° e 0°, guaina in PVC flessibile







Ø 12 - 35 MM

104.5060 **Inox Steel**

Tagliatubi a cricchetto

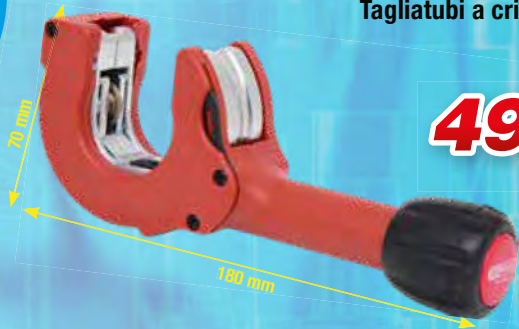

**49,90**



Ø 28 - 67 MM

104.5050 **Inox Steel**

Tagliatubi a cricchetto



**149,90**

116.1050

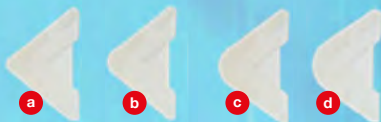

**FUGENFIX**™

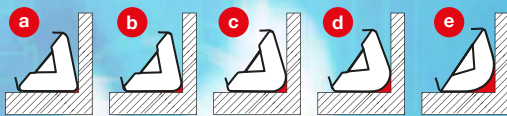

**10,90**

Assortimento FUGENFIX raschietto per silicone ed estrattore



903.3300

Serie di filiere 3/8" - 1.1/4"

3/8"  
1/2"  
3/4"  
1"  
1.1/4"

**89,90**





116.2000



**59,90**

Chiave per pilette

130.3000

1/2"



3/8" - 1/2"  
3/4" - 1"

90 mm

270 mm



**29,90**

Serie di chiavi per radiatori universale 3/8" - 1"

903.5902

- Temperatura fiamma ca. 1700°C
- Temperatura di lavoro ca. 650°C
- Saldatura fino a max. Ø 22 mm
- La fornitura non comprende la cartuccia di gas
- Impiego solo con bruciatore standard a prestazioni elevate
- Corpo in materiale plastico

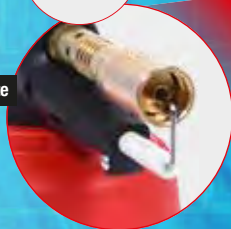

**28,90**

Saldatore a cartuccia universale con accensione piezoelettrica

907.2113

Sega giapponese, con dentatura doppia



17x  
pro 2,5cm

8x  
pro 2,5cm

329 mm

**19,90**



850.0300

Borsa portautensili universale SMARTBAG

**75,90**

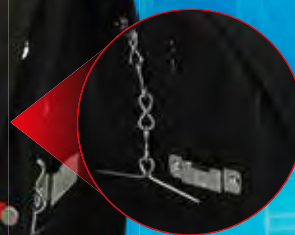



NOVITÀ



### Design compatto e robusto:

Grazie all'alta qualità di plastica e tenute la batteria ricaricabile è protetta da urti e agenti esterni.



### Sistema a batteria da 18V e MONSTER

La piattaforma 18V eMONSTER riunisce tutta la serie di elettrotensili professionali. Tutti gli apparecchi possono essere azionati con la stessa batteria. La gamma base potrà essere ampliata costantemente. Ogni nuovo apparecchio sarà compatibile con le batterie già in dotazione. In questo modo sarà possibile sfruttare la piattaforma 18V eMONSTER nel tempo.



### Dissipazione di calore:

Grazie alla struttura ad lamelle il calore viene dissipato all'esterno come nel caso di un radiatore.



### Protezione supplementare per una lunaga durata della batteria:

**Protezione da sovratensioni**  
• Protezione da fonti di tensione eccessivamente elevate

### Protezione da bassa tensione

• Protezione dai problemi di scarica profonda

### Gestione della temperatura

• Interazione tra apparecchio e batteria, per evitare un sovraccarico della batteria



### Ventilazione ad aria attiva:

(solo per caricabatteria da 8,0 Ah) La ventola integrata del caricabatteria rapido da 8,0 Ah fornisce durante l'operazione di ricarica in modo continuo aria fresca a bassa temperatura, per ridurre il calore che si origina nella batteria e nel caricabatteria. Grazie a questa operazione di ricarica delicata la durata della batteria viene notevolmente incrementata.



### Disposizione ottimizzata delle celle:

Grazie alla struttura tubolare le singole celle vengono inserite nella plastica che dissipa il calore. In questo modo si sviluppa un contatto tra la cella e la plastica che dissipa il calore. Non è più presente alcuno strato isolante d'aria che riduce la dissipazione di calore.







Serie di avvitatori e alesatori a batterie brushless eMONSTER



Serie di avvitatori, alesatori e attrezzi a percussione a batterie brushless eMONSTER

**MINI**



**169,90**

Coppia max.: 40 Nm  
Attacco: Mandrino di perforazione a serraggio rapido da 10 mm

515.6400

**COMPRESI**



Tensione della batteria: 18,0 V  
Max. corrente di ricarica: 3 A  
  
Tensione della batteria: 18,0 V  
Tecnologia batterie ricaricabili: Ioni di litio  
Capacità batteria: 2,0 Ah

Consegna comprensiva di due batterie 2.0Ah e in caricabatteria rapido da 3 A



**194,90**

Coppia max.: 60 Nm  
Attacco: Mandrino di perforazione a serraggio rapido di metallo Röhmm da 13 mm

515.6300

**COMPRESI**



Serie di avvitatori a percussione a batterie brushless eMONSTER 1/2"



Serie di smerigliatrici ad angolo a batterie brushless eMONSTER



**279,90**

Coppia max per svitare: 690 Nm  
Attacco: 1/2"

515.6100

**COMPRESI**



Tensione della batteria: 18,0 V  
Max. corrente di ricarica: 8 A  
  
Tensione della batteria: 18,0 V  
Tecnologia batterie ricaricabili: Ioni di litio  
Capacità batteria: 4,0 Ah

Consegna comprensiva di due batterie 4.0Ah e in caricabatteria rapido da 8 A



**329,90**

Numero giri max: 9000 Giri/min.  
Accelerazione vibrazioni: < 4,831 m/s<sup>2</sup>  
3,371 m/s<sup>2</sup>

515.6200

**i** **32**  
Ulteriori informazioni



Serie di inserti TORSIONpower, 25 mm 1/4" eMONSTER, 32 pz

**13,90**

515.6932

1 x		1/4"
1 x		1/4"
4 x		3 - 4 - 5 - 6 mm
4 x		PH1 - 2 x PH2 - PH3
4 x		PZ1 - 2 x PZ2 - PZ3
4 x		3 - 4 - 5 - 6 mm
7 x		T10 - T15 - T20 - T25 - T27 - T30 - T40
7 x		TB10 - TB15 - TB20 - TB25 - TB27 - TB30 - TB40

Può essere collegato e bloccato agli apparecchi eMONSTER da 18 V come falsa batteria



# QUI SI PROCEDE COLPO SU COLPO!

**1.390 N·m**

1/2"

90 mm

165 mm

515.1150

1  **245,00**

**1.390 N·m**

1/2"

95 mm

190 mm

515.1270

2  **199,90**

**1.084 N·m**

1/2"

115 mm

180 mm

515.1315

3  **89,90**

**1.600 N·m**

1/2"

170 mm

188 mm

515.1200

4  **89,90**

**2.000 N·m**

3/4"

170 mm

185 mm

515.3400

5  **159,90**

**1.690 N·m**

1/2" 3/4"

175 mm

200 mm

515.1210

6  **199,90**

7  **259,00**

**3.405 N·m**

3/4" 1"

40 mm

350 mm

515.3250

9  **1049,90**

11  **1049,90**

**3.405 N·m**

3/4" 1"

195 mm

350 mm

515.3260

10  **1114,90**

12  **1114,90**

			 MAX Nm	 U/min	 m/s <sup>2</sup>	 dbA	 dbA	 U/min	 PT				 Kg
1	515.1150	1/2"	1390	10.000	<9,18	102,0	113,0	135	1/4"	-	✓	-	1,08
2	515.1270	1/2"	1390	10.000	<9,18	102,0	113,0	135	1/4"	-	✓	-	1,3
3	515.1315	1/2"	1084	9000	<10,36	106,0	115,0	169	1/4"	-	✓	-	1,2
4	515.1200	1/2"	1600	8500	<17,5	89,9	100,9	169	1/4"	✓	-	-	2,1
5	515.3400	3/4"	2000	8500	<17,25	91,0	100,9	196	1/4"	✓	-	-	2,2
6	515.1210	1/2"	1690	7930	<17,9	87,0	98,0	178	1/4"	✓	-	-	2,1
7	515.3785	3/4"	1690	7930	<13,56	88,0	104,0	178	1/4"	✓	-	-	2,2
8	512.0002	1/2"	2300	8500	<8,69	99,7	110,9	244	1/4"	✓	-	✓	1,6
9	515.3250	3/4"	3405	6200	<12,57	115,5	104,5	283	1/2"	✓	-	-	6,7
10	515.3260	3/4"	3405	6200	<12,88	115,5	104,5	283	1/2"	✓	-	-	7,7
11	515.3270	1"	3405	6200	<12,57	115,5	104,5	283	1/2"	✓	-	-	6,7
12	515.3280	1"	3405	6200	<12,88	115,5	104,5	283	1/2"	✓	-	-	7,8

 Robusto meccanismo di percussione "DOUBLE Hammer"

 Massa battente Jumbo ad alte prestazioni

 Tecnologia BITURBO

Tutti i prezzi in EUR più IVA valgono fino al 30/09/2024



# BITURBO 2.300 NM IN SOLO ~ 15 SECONDI!

170 mm

185 mm



## ROCKET II 2300 VB BITURBO

### DUE CANALI DELL'ARIA, DOPPIA POTENZA!

Due canali dell'aria alimentano il potente motore biturbo azionato a 8 palette. Come nelle auto: prima si avvia il turbocompressore e successivamente si avvia il secondo meccanismo assicurando così una potenza maggiore.



Robusto meccanismo di percussione "DOUBLE Hammer"

NOVITÀ

BITURBO

VB = 8, ANZICHÉ 6 PALE DEL ROTORE

512.0002

8



# 149,90

MIGLIORE PROGETTAZIONE DELLO SCARICO DELL'ARIA

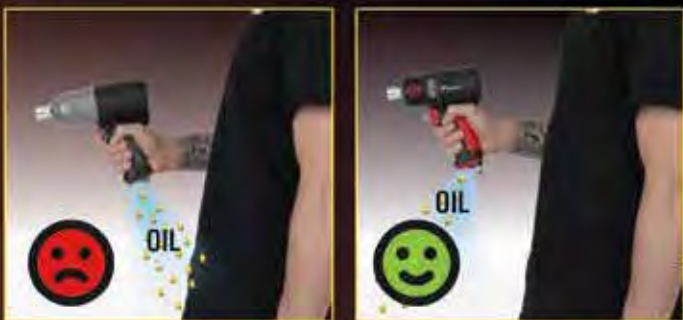

max.  
2.300  
Nm

SOLO!  
1,6 KG

1/4" PT	8.500 rpm	max. 2300 Nm	max. 851 Nm	max. 1256 Nm	244 L/min	6,3 bar	3,8" - 10,0 mm	1,6 kg	<8,69 m³/s	110,9 dbA	99,7 dbA	max. M 16
---------	-----------	--------------	-------------	--------------	-----------	---------	----------------	--------	------------	-----------	----------	-----------

Tutti i prezzi in EUR più IVA valgono fino al 30/09/2024

2° GENERAZIONE - 2° GENERAZIONE - 2° GENERAZIONE - 2° GENERAZIONE - 2° GENERAZIONE



**i** **1**  
Ulteriori informazioni

**i** **Trasporto lubrificante: Una corsa ad ogni azionamento del grilletto**

**69,90**

515.3900 **Ingrassatore aria compressa per pompaggio a intermittenza**

**i** **1**  
Ulteriori informazioni

**da 29,90**

**PU** ✓

515.3330	6,0 mm	G1/4" AG	8,0 m	29,90 €
515.3335	8,0 mm	G1/4" AG	15,0 m	39,90 €
515.3340	10,0 mm	G3/8" AG	15,0 m	45,90 €

**i** **1**  
Ulteriori informazioni

**11,90**

regolabile

100 mm

**515.1901** **Pistola per aria compressa con regolazione del getto**

**i** **3**  
Ulteriori informazioni

**21,90**

510 mm  
330 mm  
95 mm

**515.1921** **Serie di pistole per soffiare aria compressa**

**Avvolgitubi per aria compressa automatico**

15 m  
1,5 m  
180°

**515.3445**

**i** **1**  
Ulteriori informazioni

**135,90**

**Ø 10 MM X 15 M**

**A**

**Dati tecnici:**  
 Diametro interno tubo: 10,0 mm  
 Pressione max: 20,0 bar  
 Attacco filettato: 1/4"

**515.3440**

**i** **1**  
Ulteriori informazioni

**199,90**

**Ø 13 MM X 15 M**

**B**

**Dati tecnici:**  
 Diametro interno tubo: 13,0 mm  
 Pressione max: 20,0 bar  
 Attacco filettato: 3/8"

**515.3445**



**i** **1**  
Ulteriori informazioni

480 mm  
320 mm  
1.150 mm  
36 mm  
36 mm  
550 mm

**da**  
**14,90**

	↔		
<b>A</b>	500.8040	480 mm	14,90 €
<b>B</b>	500.8045	1.150 mm	49,90 €

**i** **1**  
Ulteriori informazioni

360 mm  
365 mm  
360 mm

**1**  
**55,90**

500.8020

**i** **1**  
Ulteriori informazioni

400 - 540 mm

**2**  
**84,90**

500.8030

**i** **1**  
Ulteriori informazioni

**MOLTO ROBUSTO  
CON 135 KG**

max. 135 kg  
463 - 580 mm  
360 mm

**3**  
**79,90**

500.8004

**i** **1**  
Ulteriori informazioni

400 mm  
85 mm  
490 mm  
1.040 mm

**4**  
**83,90**

500.8011

**i** **1**  
Ulteriori informazioni

420 mm  
145 mm  
1.200 mm  
510 mm  
145 mm

**6**  
**119,90**

500.8000

	<b>1</b>	<b>2</b>	<b>3</b>	<b>4</b>	<b>5</b>	<b>6</b>
<b>Dati tecnici:</b>	500.8020	500.8030	500.8004	500.8011	500.8090	500.8000
Colore	rosso	rosso	rosso	rosso	rosso	rosso
Materiale	Tubo in acciaio	Metallo	Metallo	Metallo	Plastica	Metallo
Numero ruote pivotanti	4	5	5	6	6	6
Su ruote	✓	✓	✓	✓	✓	✓
Tipo di pneumatici	Plastica	Plastica	Gomma	Plastica	Plastica	Plastica
Imbottito	✓	✓	✓	✓	✗	✓
Protezione obiettivo	✗	✓	✓	✓	✗	✓
Contenuto della confezione	1	1	1	1	1	1
Lunghezza totale L in mm	365,0 mm	370,0 mm	360,0 mm	1040,0 mm	1030,0 mm	1200,0 mm
Larghezza B	360,0 mm	370,0 mm	360,0 mm	490,0 mm	480,0 mm	420,0 mm
Altezza H	360,0 mm	420,0 - 540,0 mm	463,0 - 580,0 mm	85,0 - 400,0 mm	115,0 mm	145,0 - 510,0 mm
Portata totale kg	90 kg	90 kg	135 kg	90 kg	120 kg	90 kg

**i** **1**  
Ulteriori informazioni

**IL PIÙ LEGGERO**

480 mm  
1.030 mm  
115 mm

**5**  
**73,90**

500.8090



**i**  **3**  
Ulteriori informazioni

**Flessibili in modo geniale**

**NOVITÀ**

**55,90**

500.8077 **Serie di supporti in silicone per utensili**

1 **53 x 29,5 x 3,2 cm**

2 **25,5 x 23,3 x 2,4 cm**

3 **27,5 x 14,5 x 2,4 cm**

**i**  **1**  
Ulteriori informazioni

- Con profilo antiscivolo sulla piattaforma
- Con piattaforma più grande per una stabilità maggiore
- La copertura in plastica dei piedini evita di danneggiare piattaforma e pavimento

**129,90**

800.0960 **Piattaforma di sicurezza in alluminio**

**TESTATO DAL TÜV SÜD PER LA VOSTRA SICUREZZA!**

960 mm

300 mm

495 mm

max. 150 kg

**i**  **1**  
Ulteriori informazioni

- Con gradino in lamiera zigrinata
- Si evitano così possibili incidenti dovuti all'instabilità del supporto.
- Pieghevole e quindi salvaspazio

**69,90**

800.0965 **Scala autostabile a gradini in alluminio**

600 mm

440 mm

620 mm

max. 150 kg



**i** 1  
Ulteriori informazioni

**MASSIMA SUPERFICIE DI LAVORO**

**1359,00**

**XXL**

840 mm

2000 mm

680 mm

865.0201 **Banco da lavoro XXL con 3 cassetti e 1 anta**

**i** 1  
Ulteriori informazioni

**PICCOLO MA ANCHE IL PIÙ GRANDE!**

257 - 1380 mm

845 - 1320 mm

257 - 1380 mm

**229,90**

500.8100 **Carrello universale telescopico multiuso con ruote**

**i** 1  
Ulteriori informazioni

Ø 440 mm

180°

**NOVITÀ**

3 5000 rpm, 57 dB, 4,9 m/s, 56,9 W

2 4500 rpm, 51,5 dB, 4,3 m/s, 53 W

1 4000 rpm, 48 dB, 3,5 m/s, 49 W

**56,90**

610 mm

570 mm

**ESTREMAMENTE SILENZIOSA ULTRALEGGERA < 3,5 KG**

999.2000 **Ventilatore per officina, 70 Watt**

**i** 1  
Ulteriori informazioni

**Morsa parallela**

360°

360°

Con base girevole

da **179,00**

Ganasce e incudine temprate

914.0004	120 mm	4"	179,00 €
914.0005	140 mm	5"	219,00 €
914.0006	160 mm	6"	239,00 €
914.0008	200 mm	8"	289,00 €



**i**

Ulteriori informazioni

max. 8 bar (116 PSI)	60° C 140° F

23,90

**1**

Water

**2**

Detergent

**3**

**4**

**5**

Switch

Lock

Max. 40° C  
Max.

150.8271 Nebulizzatore schiumogeno a pompa (erogatore di schiuma)

**i**

Ulteriori informazioni

95,90

350 mm

650 mm

500.8013 Sgabello mobile

**i**

Ulteriori informazioni

6,3 bar	96 L/min
92 dbA	1/4" PT

45,90

Aspirare

Soffiare

145 mm

3/8" - Ø 10 mm

515.5090 Pistola aspiratrice ad aria compressa



**1**  
Ulteriori informazioni

Ø 90 mm

**7,50**

515.1243 Disco abrasivo

**1**  
Ulteriori informazioni

24 mm

Ø 100 mm

**18,90**

515.1247 Disco abrasivo con lamelle

**6**  
Ulteriori informazioni

**PREZZO SERIE = 6X**

**39,50**

515.1285

**6**  
Ulteriori informazioni

**PREZZO SERIE = 6X**

**104,50**

515.1366

**1**  
Ulteriori informazioni

**159,90**

515.1980 Pistola per pulizia ad aria compressa

**Cuscinetti a sfera industriali**

**regolabile**

ON - OFF

360°

30°

1/4" NPT	8000	160 Litri
6,3 bar (90psi)	3/8" 10 mm	<3,90 m/s²
106 dbA	95 dbA	1000 ml

**OPZIONALE**

**1**  
Ulteriori informazioni

**7,90**

515.1983 Spazzola

**1**  
Ulteriori informazioni

**7,90**

515.1986 Spazzola a pennello



**i** **6**  
Ulteriori informazioni

**34,90**

510 mm

4 mm  
8 mm  
10 mm

4 mm  
8 mm  
10 mm

245 mm

**140.2370 Set allentamento clip**

**i** **11**  
Ulteriori informazioni

**25,90**

180 mm 200 mm 200 mm 200 mm 210 mm

160 mm 200 mm 200 mm 180 mm 200 mm 200 mm

**911.8205 Serie di cunei in plastica MASTER**

**i** **1**  
Ulteriori informazioni

DC 12V 24V AC 100-240V 50/60 Hz

- Elimina gli odori e disinfetta gli interni del veicolo
- Disattivazione automatica in modalità elimina odori dopo 60 minuti
- Lavora senza additivi chimici, quindi garantisce una pulizia senza residui
- Non lascia tracce su superfici sensibili
- Elimina muffe, batteri, funghi e acari!

173 mm

49 mm

122 mm

**89,90**

**550.1183 Purificatore d'aria al plasma con ionizzatore**

**i** **1**  
Ulteriori informazioni

- Ideale per la pulizia di tubi stretti, tubi flessibili o scarichi
- Utilizzabile su entrambi i lati
- Manico in acciaio inox
- Setole in nylon

**5,90** **NOVITÀ**

Ø 16 mm

Ø 22 mm

**150.1762 Spazzola flessibile per pulizia**

**i** **7**  
Ulteriori informazioni

Ø 0 - 38 mm

Ø 0 - 48,5 mm

Ø 0 - 65 mm

Ø 0 - 30 mm

Ø 0 - 45 mm

Ø 0 - 45 mm

Ø 0 - 60 mm

**94,90**

**115.1055 Serie di pinze per fascette stringitubi per autovetture**



**i** **3**  
Ulteriori informazioni

**13,90**

Ø 15 mm    Ø 30 mm    Ø 60 mm

150 mm    180 mm    250 mm

115.5050

**i** **3**  
Ulteriori informazioni

Ø 35 mm    Ø 23 mm

155 mm    255 mm    165 mm

**16,90**

115.5055

**i** **1**  
Ulteriori informazioni

**19,90**

Pompa manuale di aspirazione e riempimento

150.9221

**i** **1**  
Ulteriori informazioni

**23,90**

100 mm

3/8" Bussola speciale per connettori del tubo di aspirazione

150.2519

**i** **1**  
Ulteriori informazioni

**23,90**

12V 5A 60W  
Richtung Direction  
150.2620

PETROL DIESEL OIL

Pompa elettrica di aspirazione e trasferimento dell'olio

150.2620

**i** **1**  
Ulteriori informazioni

**6,90**

NOVITÀ

Bussola intercambiabile per fascette per tubi da 30-45 mm e da 60-80 mm

30 mm

115.0915

Chiave a bussola speciale 2 in 1 per fascette per tubi flessibili con profilo a 3 punti

**i** **1**  
Ulteriori informazioni

**17,90**

NOVITÀ

1/2"

108 mm

150.1919

Utensile di sblocco del tappo del radiatore per VAG







25

Ulteriori informazioni











0 - 2,5 bar

max. 76 cm

0 - 200 °C  
0 - 400 °F

1600 mm



R123  
R124



R123  
R125



#1



#2



#3



M50 x 2,5



M42 x 3



M58 x 3



M62 x 3



M48 x 4



M45 x 3



M50 x 2,5



M60 x 4



M52 x 3



M48 x 2,5



M42 x 2,5



M50 x 3



M46 x 3



M34 x 2,5



75 mm

# 239,<sup>90</sup>

**Serie di utensili per  
manutenzione e diagnosi dell'impianto di raffreddamento MASTER**



150.1930





1

Ulteriori informazioni

**Giunto da 7,2 mm su 4,4 mm**



7,2 mm



4,4 mm

**NOVITÀ**

# 24,<sup>90</sup>

150.1936





1

Ulteriori informazioni

**Giunto da 4,4 mm su 7,2 mm**



4,4 mm



7,2 mm

**NOVITÀ**

# 30,<sup>90</sup>

150.1937



**i**  **8**  
Ulteriori informazioni

250 ml

**119,90**

150.1910 Set per testare le perdite di CO2 nella testata motore

**OPZIONALE**

**16,90**

150.1914

**i**  **3**  
Ulteriori informazioni

**FLESSIBILI IN MODO GENIALE**

53 x 29,5 x 3,2 cm

**1**

**2** 25,5 x 23,3 x 2,4 cm

**3** 27,5 x 14,5 x 2,4 cm

**NOVITÀ**

**55,90**

500.8077 Serie di supporti in silicone per utensili



**i** **2**  
Ulteriori informazioni

**Ford EcoBoost**

**NOVITÀ**

14 mm + 16 mm

180 mm + 215 mm

**30,50**

**PER MOTORI FORD ECOBOOST DA 1,0 LITRI**

**PER MOTORI FORD ECOBOOST DA 1,5 LITRI**

517.1135 Serie di bussole per candele per motori EcoBoost

**i** **2**  
Ulteriori informazioni

M20 x 1.5 + M22 x 1.5

27 mm

13 mm

- Per ravvivare i filetti delle sonde arrugginiti e danneggiati
- Ideale per sensori NOX e di filtro antiparticolato su impianti di gas di scarico
- Con 6 taglienti per un centraggio ideale
- Versione particolarmente corta
- Con scanalatura di pulizia nel perno di guida

Con 6 taglienti per un centraggio ideale

Con scanalatura di pulizia nel perno di guida

**229,90**

150.2540 Serie di filettatrici con perno di guida per sensori

**RISOLUTORE DI PROBLEMI GENIALI**

**NOVITÀ**

**i** **1**  
Ulteriori informazioni

**Filettatrice con perno di guida**

- Per ravvivare i filetti arrugginiti e danneggiati delle sonde

L1 L2

13 mm

Con 6 taglienti per un centraggio ideale

Con scanalatura di pulizia nel perno di guida

**129,90**

			L1	L2			
<b>A</b>	150.2541	per sensori di temperatura	M12 x 1,25	55 mm	33 mm	13 mm	129,90 €
<b>B</b>	150.2542	per sensori di temperatura	M14 x 1,5	45 mm	30 mm	13 mm	129,90 €
<b>C</b>	150.2543	per sonde Lambda	M18 x 1,5	42 mm	27 mm	13 mm	129,90 €
<b>D</b>	150.2544	per sensori NOX	M20 x 1,5	50 mm	27 mm	13 mm	129,90 €
<b>E</b>	150.2546	per sensori filtro antiparticolato	M22 x 1,5	50 mm	27 mm	13 mm	129,90 €



**i**  **1**  
 Ulteriori informazioni **22,90**



**1** **2**

**500.7505** Estrattore per bobine di accensione



**i**  **7**  
 Ulteriori informazioni **PER MOTORI VAG E OPEL**

**75,90**



**1** **2** **3** **4** **5** **6** **7**

**500.7570** Set di estrattori per bobina di accensione con impugnatura a T per motori VAG e Opel







**i**  **7**  
 Ulteriori informazioni

120 ml 120 ml



6x10  
6x6  
6x8  
6x4  
600 mm  
Ø 6x9 mm

**189,90**

**150.1900** Serie pompa pressione / vuoto



**i**  **24**  
 Ulteriori informazioni



**53,90**

**700.1280** Serie di utensili di montaggio per anello di tenuta albero e Simmering





**i** **1**  
Ulteriori informazioni

**45,90**

**150.3170 Estrattore universale a 2 bracci per pulegge**

**i** **1**  
Ulteriori informazioni

**NOVITÀ**

- per il tensionamento e l'allentamento del tendicinghia della cinghia dentata
- Regolabile, impiego universale
- Attacco quadro femmina a norma DIN 3120 / ISO 1174 con sede per sfera di tenuta
- Con attacco esagonale 13,0 mm
- Fosfatata

**24,90**

**150.3046 Chiave a denti universale per rullo tendicinghia per cinghie dentate, regolabile**

**i** **1**  
Ulteriori informazioni

Campi di applicazione: Citroën, Peugeot, Opel e Toyota Con motori benzina 1,0 e 1,2 (codice motore: ZMZ (EB0F / EB0) / HMO1 (1PP) / HMV, HMZ (EB2) / HMZ (EB2 / EB2F) / HMT (EB2D) / HMO (EB2D) / HNZ (EB2DT) / HNY (EB2DTS) / HMV (EB2M) / HMY (EB2M) / B12XE (EB2F) / D12XE (EB2FA) / B12XHL (EB2DT) / D12XHL, F12XHL (EB2A-DT) / B12XHT (EB2DTS) / D12XHT, F12XHT (EB2ADTS)

**12,90**

**400.2118 Tester della cinghia di distribuzione per PSA**

**i** **1**  
Ulteriori informazioni

**39,90**

**150.3130 Estrattore universale a 3 bracci per pulegge**

**i** **22**  
Ulteriori informazioni

- Per il montaggio e lo smontaggio di giunti a innesto rapido CLIC per le tubazioni del carburante, dell'impianto di climatizzazione, di ventilazione e dell'impianto idraulico
- Nessun danno agli innesti rapidi e ai tubi del carburante
- Separazione rapida e semplice dei tubi del carburante
- Per quasi tutti i tipi di giunti di veicoli europei, asiatici e americani

**115.1260 Set di sblocco del connettore di linea**

**54,90**





Ulteriori informazioni

# CON 3.873 BATTUTE AL MINUTO ESTRAE OGNI COSA!

## NOVITÀ

- Inclusi 7 adattatori per quasi tutti gli iniettori
- Effetto di battuta estremamente elevato (3365 (6,3 bar) / 3873 (8 bar) battute al minuto)
- Per lo smontaggio degli iniettori bruciati nella testata
- Utilizzando un adattatore corrispondente, l'estrattore viene avvitato sull'iniettore bloccato
- Ingombri ridotti grazie ad una struttura compatta



A B C



D



E F G H



3.873 x / min



1/4"

regolabile

230 mm

223 L/min	3/4"-19 mm	108,4 dbA
6,3 bar (90 psi)	71,9 m/s²	6 mm
12 bar	119,4 dbA	M18 x 1,5

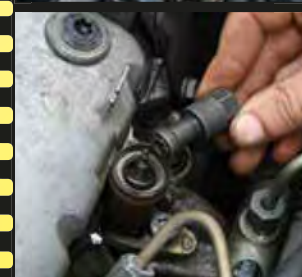
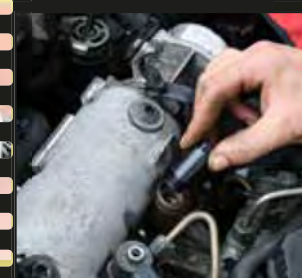
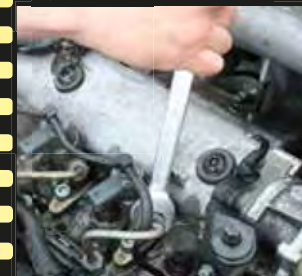

A	M25 x 1,0	Siemens
B	M20 x 1,0	Denso
C	M27 x 1,0	Siemens
D	M27/M17/10 mm	Bosch/Fiat/BMW/PSA/Mercedes/Renault
E	M18 x 1,5	Adattatore
F	M17 x 1,0	Bosch/Mercedes
G	M16 x 1,0	Toyota
H	M14 x 1,5	Bosch/Delphi/BMW

**BOSCH** ✓  
**DENSO** ✓  
**DELPHI** ✓  
**SIEMENS** ✓

...

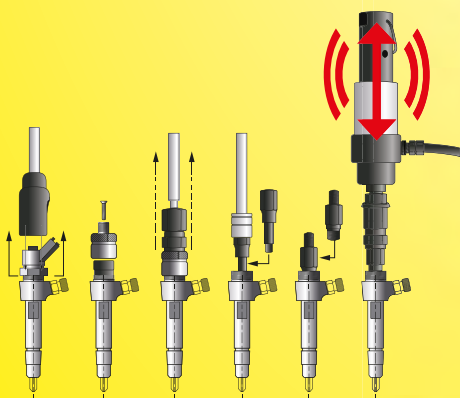

# 279,90

152.1130 Serie di estrattori per iniettori pneumatici



**6**  
Ulteriori informazioni

285 - 875 mm  
ALLUNGABILE IN MODO TELESCOPICO  
150 - 675 mm

500g  
200g  
1000g  
2000g  
3000g

Ø 4 mm  
Ø 13 mm  
Ø 16 mm  
Ø 19 mm

400 mm  
510 mm

**NOVITÀ**

**32,00**

550.1090 **Supporto magnetico flessibile e telescopico e serie di specchi per ispezione**

**1**  
Ulteriori informazioni

125 mm

6 - 24 V  
**5,90**

550.1504 **Tester luminoso 6 - 24 V**

**1**  
Ulteriori informazioni

**12,90**

3 - 48 V

Tester di polarità e cercafase

550.1503

**2**  
Ulteriori informazioni

**149,90**

25 m

6 - 24 V

Tester luminoso

150.1655

**2**  
Ulteriori informazioni

**1** Ricevitore

**2** Trasmettitore con morsetti a coccodrillo

**64,90**

150.3075 **Rilevatore di corto circuiti**







Ulteriori informazioni





# 365,<sup>00</sup>

 **Caricare la batteria**  
 **Ricarica di mantenimento**  
 **Riparazione della batteria**  
 **Alimentazione in corrente continua**  

12V ● 24V

**Commutabile tra 12 e 24 Volt**





Sensore di temperatura



**Dati tecnici:**

Capacità della batteria:	12V: 75-500Ah - 24V: 45-250Ah
Range di tensione:	220-240V AC, 50/60Hz
Tensione di carica:	14,4V - 25A (12V), 28,8V - 12,5A (24V)
Gamma di frequenze:	50 Hz
Cablaggio:	H05RN-F 2x1,0 mm <sup>2</sup>



**550.1745 Caricabatterie 12V + 24V SMARTcharger ad alta frequenza 25A/12,5A**





Ulteriori informazioni





Per quasi tutte le batterie

Con stampante e 3 rotoli di carta

# 399,<sup>90</sup>



**550.1649 Tester digitale 12V / 24V per batterie e sistemi di ricarica con stampante integrata**







START



STOP

**Dati tecnici:**

Display:	digitale
Campo di applicazione CA / MCA:	40-2.000 CCA
Campo di applicazione CCA:	40-2.000 CCA
Campo di applicazione DIN:	40-2.000 CCA
Campo di applicazione EN:	40-2.000 CCA
Campo di applicazione IEC:	40-2.000 CCA
Campo di applicazione JIS#:	40-2.000 CCA
Campo di applicazione SAE:	40-2.000 CCA
Temperatura di lavoro:	+0°C - +55°C
Gamma di frequenze:	100 Hz
Campo di misura:	9-36 V
Precisione di misurazione:	+/- 0,5 Megaohm
Range di tensione:	9-36 V





Ulteriori informazioni











# 649,<sup>90</sup>



**550.1720 Booster per batterie 12 V + 24 V - starter mobile 1400 A**





# 1.400 A



Una concezione intelligente della sicurezza previene eventuali errori dell'utente:

Il circuito di sicurezza fornisce corrente ai morsetti soltanto se:

- il collegamento è stato effettuato in modo corretto (polarità)
- il collegamento è protetto da eventuali cortocircuiti
- è applicata la tensione corretta
- la batteria del veicolo è in perfetto stato



**i** **26**  
Ulteriori informazioni

**DVE** **GS**  
1000 V

**3/8"**

**399,90**

Kit di utensili isolati per veicoli ibridi ed elettrici

117.1895

2 x		4 mm - 5,5 mm
2 x		PH1 - PH2
6 x		6 - 8 - 10 - 12 - 13 - 17 mm
1 x		185 mm
1 x		165 mm
1 x		3/8"
1 x		3/8": 200 mm
1 x		3/8": 125 mm
10 x		3/8": 8 - 10 - 11 - 12 - 13 - 14 - 16 - 17 - 19 - 22 mm
1 x		200 mm

**i** **43**  
Ulteriori informazioni

**DVE** **GS**  
1000 V

**3/8"**

**699,90**

Kit di utensili isolati per veicoli ibridi ed elettrici

117.1890

4 x		2,5 - 3 - 3,5 - 4 mm
3 x		PH1 - PH2 - PH3
3 x		T20 - T25 - T30
1 x		210 mm
1 x		185 mm
1 x		165 mm
1 x		215 mm
1 x		165 mm
1 x		240 mm
2 x		10 - 25 mm
1 x		180 mm
1 x		3/8"
15 x		3/8": 6 - 7 - 8 - 9 - 10 - 11 - 12 - 13 - 14 - 16 - 17 - 18 - 19 - 20 - 22 mm
2 x		3/8": 150 - 250 mm
3 x		3/8": M8 - M10 - M12
1 x		Ø 200 mm
1 x		200 mm
1 x		500 m

**i** **18**  
Ulteriori informazioni

**DVE** **GS**  
1000 V

**389,90**

Serie di chiavi a forchetta con isolamento di protezione

118.1500

18 x		7 - 8 - 9 - 10 - 11 - 12 - 13 - 14 - 15 - 16 - 17 - 18 - 19 - 20 - 21 - 22 - 23 - 24 mm
------	--	---

**i** **1**  
Ulteriori informazioni

**<44.500 V**

**219,90**

Asta di salvataggio isolata

150.0913

1.680 mm





Ulteriori informazioni

# STARTER SET PER VEICOLI ELETTRICI

## ecoLine



1

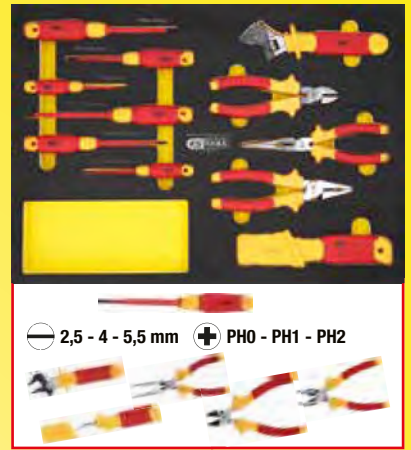

2

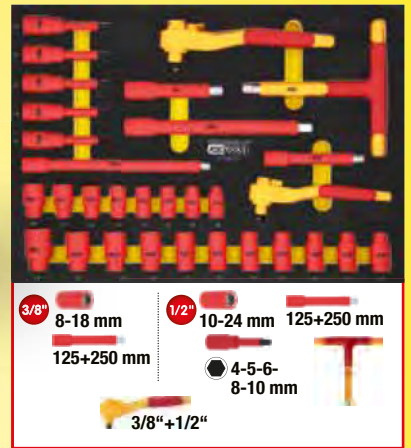

Foratura quadra per accessori

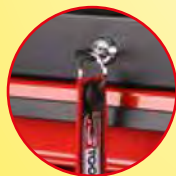

Serratura a cilindro



Rivestimento in gommapiuma di eccellente qualità incluso, spessore 10 mm



Con autoinserimento e funzione SOFT-CLOSE



2 x freni per ruote pivotanti Ø ruote: 125 mm

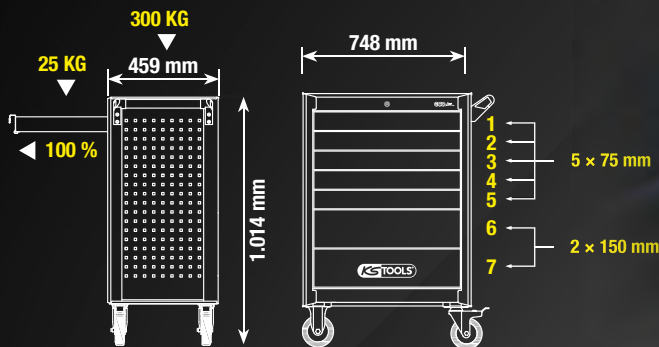

Carrello portautensili ECOline con 42 utensili isolati per veicoli ibridi ed elettrici

117.6144

# 1525,00

INCLUSI 42 UTENSILI



4699,90



117.6172 Serie di chiavi a bussola isolate 3/8" + 1/2" con chiave dinamometrica in inserto in schiuma, 72 pz



117.6133 Serie di chiavi isolate nell'inserto in schiuma, 33 pz

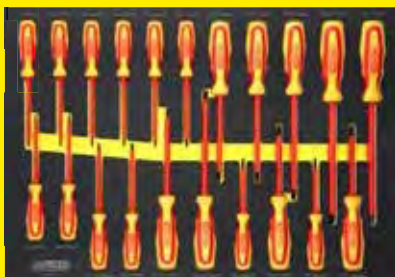

117.6121 Serie di giraviti ERGOTORQUE VDE nell'inserto in schiuma, 21 pz



117.6117 Serie di pinze ERGOTORQUE VDE nell'inserto in schiuma, 17 pz

Cartello di avvertenza lampi



200 mm

917.3898

Interruttore ibrido targhetta di avvertenza



Ø 200 mm

917.3897

Materassino isolante, 1000 mm, spessore 3,0 mm



117.3819

Sottoganti



117.1660

Guanti di protezione per elettricisti con protezione di isolamento, taglia 10, spessore 1, bianco



117.1664

Visiera protettiva per elettricisti, classe 2



117.1796

117.6155 Carrello portautensili PERFORMANCEplus e10 con 164 utensili isolati per veicoli ibridi ed elettrici

12,90



117.0223

Segnale magnetico per auto con simbolo dell'alta tensione



IL PIÙ COMPLETO DELLA SUA CATEGORIA



**12,90**

117.0222

Segnale a ventosa per auto  
con simbolo dell'alta tensione



**17,90**

117.0226

Cartello a terra per auto con  
simbolo dell'alta tensione



**89,90**

117.1550

Serie pali di delimitazione  
con catena



**159,90**

117.1545

2 x Barriera estensibile  
in plastica



Il catalogo completo sulla  
emobility è disponibile presso  
[www.kstools.com](http://www.kstools.com)



**i**  **4**  
Ulteriori informazioni

Ø 22,0 - 28,0 mm

Ø 15,0 - 21,0 mm

Ø 17,0 - 25,0 mm

**Serie di elementi di centraggio frizione**

**10,90**

150.2180 Ø 15,0 - 28,0 mm



**i**  **11**  
Ulteriori informazioni

150 kg

310 mm

450 mm

**459,90**

300 mm

160.0910

**Kit sollevatore cambio**



**i**  **3**  
Ulteriori informazioni

- 1 Montare e smontare lo strumento di riempimento A
- 2 Scaricare l'olio, flusso ridotto
- 3 Verificare il livello di riempimento
- 4 Scaricare l'olio, flusso completo

**29,90**

**9G-TRONIC**

56 mm

74,5 mm

20 mm

9 mm

28,5 mm

39,5 mm

9 mm

152 mm

48 mm

150.9695



160.0910

**Kit sollevatore cambio**



**i**  **24**  
Ulteriori informazioni

# IL PIÙ COMPLETO

**239,90**

**SERIE DI ADATTATORI DA 23 PZ. INCLUSA**

**NOVITÀ**

150.9261		1/8-27 NPT Ford
150.9262		BMW, Honda, Nissan etc.
150.9263		VAG
150.9264		VAG, Porsche
150.9265		M10 x 1.0 VAG, Mini Cooper
150.9267		M12 x 1.5 Mercedes
150.9268		M24 x 1.5 VAG DSG
150.9269		M22 x 1.5 VAG CVT
150.9271		M18 x 1.5 Skoda
150.9272		M30 x 1.5 VAG, Skoda
150.9273		Universal Flexible 300 mm, Honda, Hyundai, Kia, etc.
150.9274		5/16-24 (UNF) Volvo
150.9276		M18 x 1,5 Toyota / Lexus
150.9277		M8 x 1,0 Nissan / Infinity
150.9278		ATF-Adapter V.W, Passat
150.9562		Nissan Juke M12 x 1,25
150.9563		Mini Cooper M14 x 1,5
150.9564		Nissan M10 x 1,5
150.9566		GM M12 x 1,75
150.9567		Mercedes 725-9G
150.9102		VAG 7 DSG
150.9103		VAG 7 DSG
150.9104		VAG 7 DSG

150.9105 Serie universale sistema di riempimento olio trasmissione con serie di adattatori da 23 pz





**i**  **4**  
Ulteriori informazioni



**135,90**

$\varnothing$  30 mm

Sostegno gamba ammortizzatrice McPherson per sollevatore cambio

160.0195

**i**  **7**  
Ulteriori informazioni



6 mm

**135,90**

Serie speciale per il montaggio di ammortizzatori con tampone di finecorsa

150.9545





TESTATO DAL



PER LA VOSTRA SICUREZZA!

**i**  **6**  
Ulteriori informazioni

Universale per il 90% di tutte le molle per autoveicoli nel (auto e furgoni)



$\varnothing$  80 - 160 mm

$\varnothing$  140 - 195 mm

**PORTATA massima 26000 N**

**559,90**

500.8400 Serie universale di compressori

- Ideale per il montaggio e lo smontaggio sicuri di ammortizzatori McPherson
- Necessaria per la sostituzione degli ammortizzatori o delle molle elicoidali
- Universale per il 90% di tutte le molle per autoveicoli nel (auto e furgoni)
- Alternativa economica e robusta ai tradizionali compressori per molle
- Adatto anche per molle coniche e molle sferiche
- Con certificazione TÜV

Dati tecnici:	
Carico molla max.:	2600 kg
Apertura max.:	355,0
Capacità molla:	80,0 - 195,0 mm



TESTATO DAL



PER LA VOSTRA SICUREZZA!



389,90



500.8765 Tenditore di centraggio telescopico Audi e Seat per molle che si trovano all'interno

PER AMPLIARE IL KIT



PER COMPRESSORE  
500.8755 + 500.8765

124,90

Campi di applicazione:  
MercedesClasse E (W211 / W212), Classe C (W204), GLA (X156), GLK (X204),  
FordFocus II (MK2),BMW1er (E81),VolkswagenPassat (B8 / 3G)

500.8770 Coppia di portamolle Ø 95-110 mm

PER AMPLIARE IL KIT



449,90

500.8755 Kit universale telescopico compressione ammortizzatori per molle interne





# PER IL 95% DEI VEICOLI



Ulteriori informazioni

1

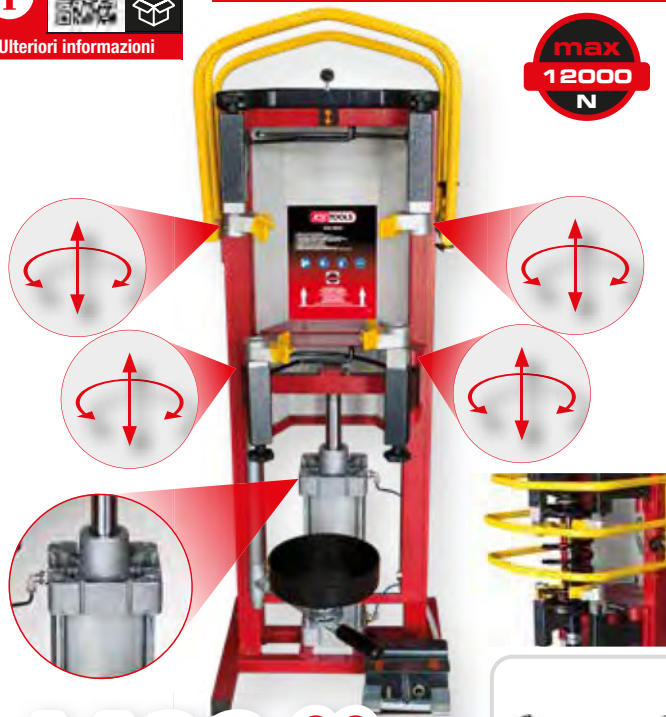

max  
12000  
N

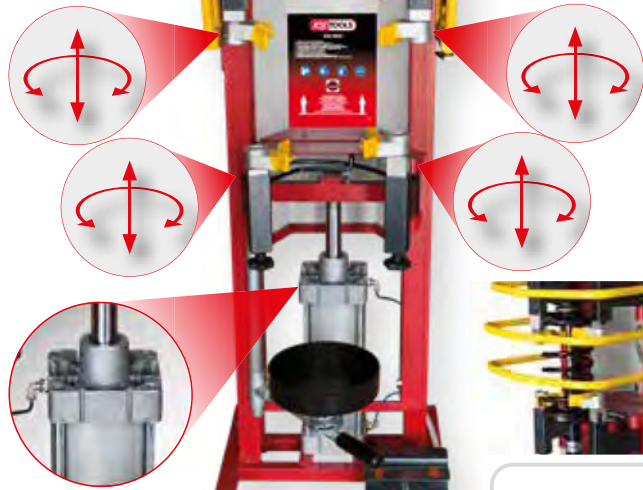

**1499,00**

Compressore pneumatico per molle ammortizzatori, max. 10 bar

500.8800



Ulteriori informazioni

1



max  
24000  
N

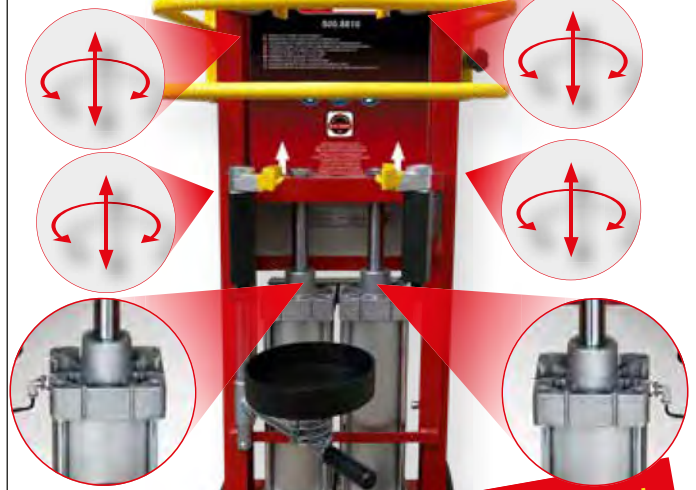

con doppio cilindro

**2150,00**

Compressore per molle banco aria compressa con doppio cilindro

500.8810

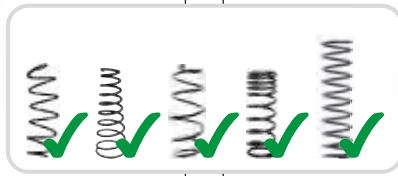

Ulteriori informazioni

1

- Facile applicazione
- Acciaio speciale per utensili
- Ideale per l'alloggiamento di ammortizzatori
- Ottimale per una posizione salda con il montaggio e lo smontaggio
- Con 4 perni di fissaggio e 4 tiranti filettati
- La fornitura comprende 2 anelli elastici per il montaggio

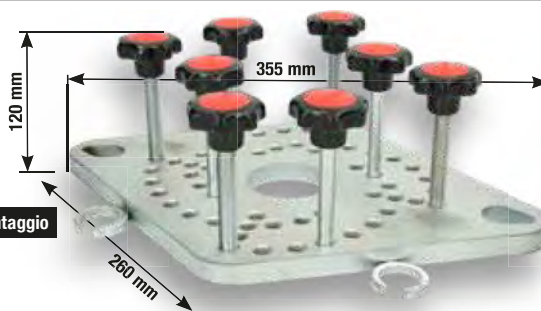

**320,00**



500.8801 Piastra adattatrice per Compressore a molle da banco ad aria compressa

## SET COMPRESSORE PER AMMORTIZZATORI INCLUSO ADATTATORE



Ulteriori informazioni

2

Compressore pneumatico per molle ammortizzatori inclusa piastra di supporto

**1850,00**

500.8805



Ulteriori informazioni

2

Compressore pneumatico per molle ammortizzatori con cilindro doppio incl. piastra di supporto

**2390,00**

500.8815



# MODULO 2 PER TENERE

## CONFIGURARE IN BASE AI PROPRI DESIDERI

440.9051



1199,<sup>90</sup>



PIÙ GRANDE DI QUANTO SI PENSI

FRENI



440.9087



2499,<sup>90</sup>

CUSCINETTO SILENT

440.9025

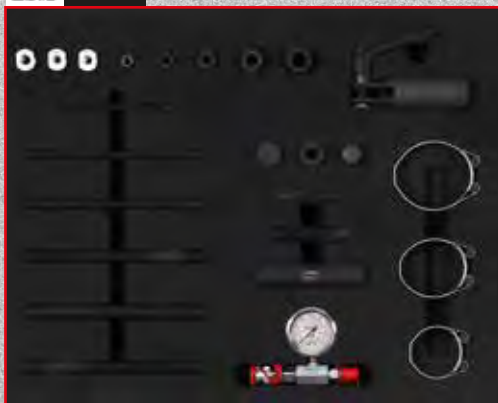

CILINDRO IDRAULICO SENZA UTENSILI DI AZIONAMENTO



440.9161



3399,<sup>90</sup>

CUSCINETTO RUOTA COMPATTO

440.9026

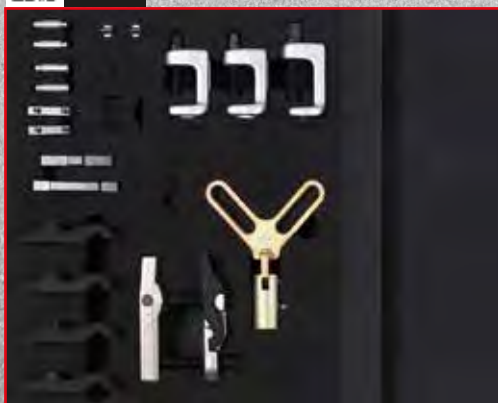

ASSALI





# IN ORDINE!

# MODULO 2



**P40**

**EDELSTAHL**  
ROSTFREI

www.kstools.com

**KSTOOLS**

Ø 155 mm

1.701 mm



873.6008

**PERFORMANCEplus P40 NERO/ROSSO**  
carrello officina con 4 cassetti

**SENZA UTENSILI**

**2799,00**



Ulteriori informazioni

**+**

2200 mm

**899,90**

Serie di pompe idrauliche  
con appoggio per P40

440.9004

**999,90**



440.9076



25

**CUSCINETTO RUOTA**



76

**1999,90**

**799,90**



440.9061



26

**AMMORTIZZATORE**



61

**1899,90**



**i**   **1**  
Ulteriori informazioni

**139,<sup>90</sup>**

max. 8 bar

450 mm

1/4" PT

Per fascette dell'asse universale

**515.3100** Divaricatore ad aria compressa per montaggio cuffie asse elasticizzate



**i**   **1**  
Ulteriori informazioni

100 mm

Ø 30 mm

255 mm

**59,<sup>90</sup>**

**150.1850** Estrattore universale per alberi di trasmissione



**i**   **1**  
Ulteriori informazioni

0 - 45 mm

270 mm

**46,<sup>90</sup>**

**115.1056** Pinza a morsetto per fascette con attacco chiave dinamometrica



**i**   **1**  
Ulteriori informazioni

**da 27,<sup>50</sup>**

Pinza per fascette autobloccanti a sfera in inox

200 - 350 mm

<b>115.1591</b>		<b>100</b>	4,6 x 200 mm	27, <sup>50</sup> €
<b>115.1592</b>		<b>100</b>	4,6 x 250 mm	27, <sup>50</sup> €
<b>115.1593</b>		<b>100</b>	4,6 x 350 mm	30, <sup>90</sup> €
<b>115.1594</b>		<b>100</b>	4,6 x 500 mm	39, <sup>90</sup> €

max. 12 mm

**59,<sup>90</sup>**

**115.1590** Pinza per fascette autobloccanti a sfera in inox



**i**   **1**  
Ulteriori informazioni

**UNIVERSAL**

10 mm

**45,<sup>90</sup>**

**700.5662** Divaricatore foro di ancoraggio





**i**  **1**  
Ulteriori informazioni

**29,90**

**Bussola portante speciale Mercedes**

150.1721  Mercedes W167, W205, W213, W238, W253, W25



**i**  **6**  
Ulteriori informazioni

**399,00**

**Serie scalpellatore ad aria compressa Vibro-Impact**

515.3880

**VIPRO**

15280316

110 mm

10 mm

110 mm

10 mm

130 mm

10 mm

100 x 25 x 12 mm

31 x 1 sec.



**i**  **3**  
Ulteriori informazioni

**33,90**

**Serie con estrattore per viti di fermo**

700.5635

10 mm



**i**  **1**  
Ulteriori informazioni

**215,90**

**Utensile per estrazione tiranti sterzo Vibro-Impact**

150.1608

- Estrazione a vibrazione di tiranti sterzo, contro avvitature o avvitature nella zona assale, ecc.
- Il mandrino speciale produce una vibrazione a impulsi al giunto a vite da allentare, sciogliendo così la ruggine e favorendo il processo di rimozione.
- Adattatore scalpello ad aria compressa 810 mm) per l'impiego con comuni martelli a percussione a scalpello

27 mm

290 mm

10 mm

65 mm







Ulteriori informazioni



700.1495 Leva universale per assali con catena

- Attraverso la catena flessibile è possibile schiacciare braccetti trasversali di diverse forme senza grande dispendio di energie



Ulteriori informazioni

- Robusta vite di pressione con filetto trapezoidale
- Pedale per una regolazione fine (20mm)
- Ideale come ausilio in officine in molte situazioni

149,90

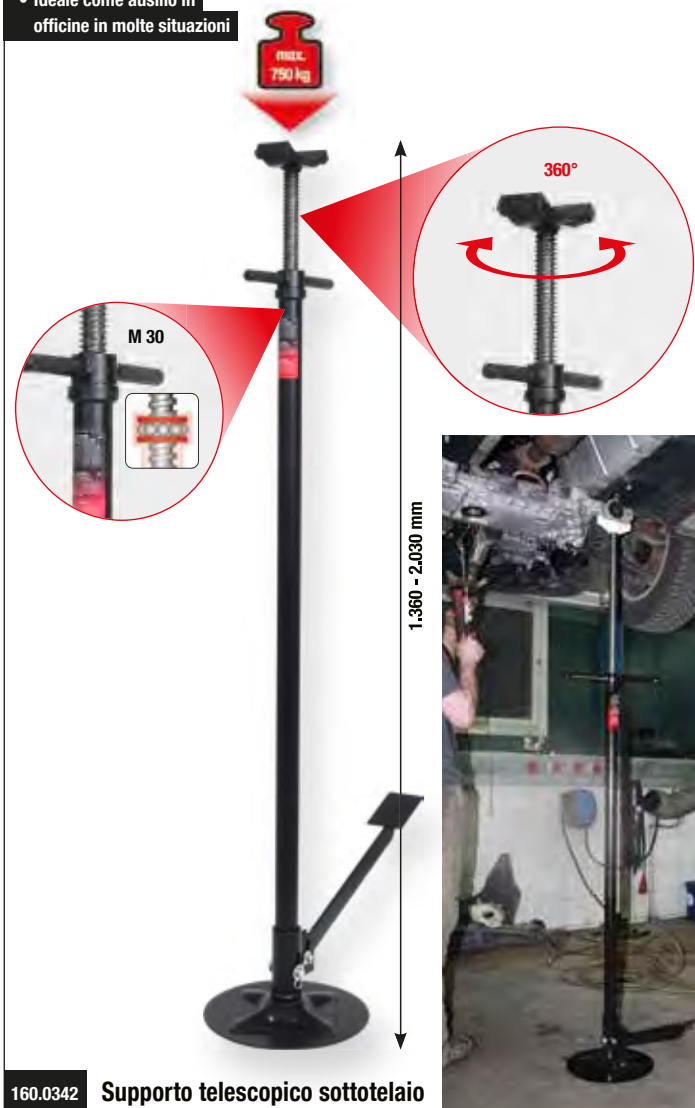

160.0342 Supporto telescopico sottotelaio



Ulteriori informazioni



911.8187 Palanchino articolato telescopico testa girevole



Ulteriori informazioni

125,90



700.1465 Tester gioco assali





Ulteriori informazioni

CON REGOLAZIONE RAPIDA



529,90

1000 W

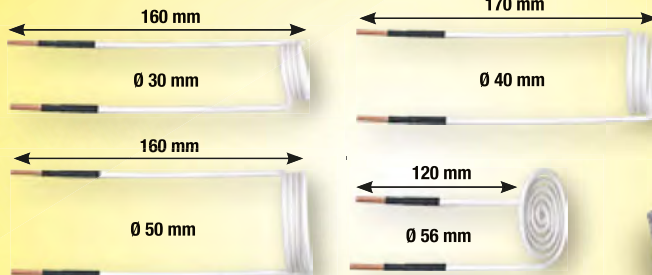

500.8605 Pistola termica ad induzione con accessori



OPZIONALE

139,90

500.8440

2° GENERAZIONE - 2° GENERAZIONE - 2° GENERAZIONE



Ulteriori informazioni

NOVITÀ

20,90

AGGANCIARE!

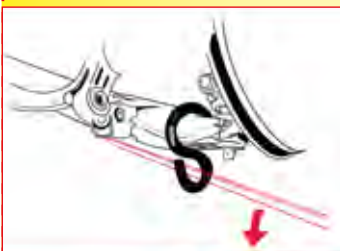

Gancio leva universale per assali

700.1499

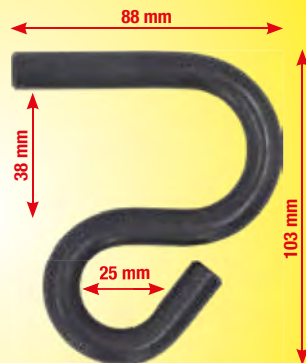

La forma speciale consente di collocarla molto vicino alla sospensione

Leva speciale per lo smontaggio e il montaggio professionale di parti dell'asse



Ulteriori informazioni



700.1550 Serie di boccole e tiranti



349,90



**i** **22**  
Ulteriori informazioni

42 40 38 36 34  
32 30 28 26 24  
#1  
#2  
#3  
#4

M12  
M10  
M12 M10 TR20

700.2355

**799,90**



**i** **4**  
Ulteriori informazioni

**95,90**

30-35 mm 35-40 mm 40-45 mm

360 mm

1/2" / 32 mm

150.1125



**i** **2**  
Ulteriori informazioni

**M12**

**NOVITÀ**

115 mm 72 mm

**26,50**

Serie di bussole speciali per avvitatori ad impulsi per viti XZN®

515.0595 1/2"

**i** **30**  
Ulteriori informazioni

1 x Ø 90 - 130 mm

1 x

4 x M 14

4 x M12 x 1,25  
M12 x 1,5

4 x M12 x 1,25  
M12 x 1,5  
M14 x 1,5

1 x M18 x 2,5 x 230 mm

M57 x 2

4,3 Kg

**249,90**

700.1530

**Serie di estrattori per mozzi ruota e alberi cardanici universale**



# MENO PERSONALE, PIÙ UTILI

# TOGLIERE IL VETRO SENZA ULTERIORE AIUTO

140.2630

## Dispositivo di estrazione cristalli utilizzabile da un solo utente

- Ideale per lo smontaggio professionale e senza danni al parabrezza e la maggior parte di vetri posteriori e laterali
- Con rullo di rinvio più grande, che permette un minor sforzo e una diminuzione del rischio di rottura del cavo
- Guidacavo connesso al disco, in questo modo non serve smontare le parti di rivestimento
- Facile da utilizzare da un solo operatore
- Ventosa di altissima qualità per una presa sicura del cristallo



Ulteriori informazioni



# ONE MAN CUT

Serie di piastre di protezione professionali, 4 pz

2x 270x200 mm + 2x 450x300 mm

**NOVITÀ**

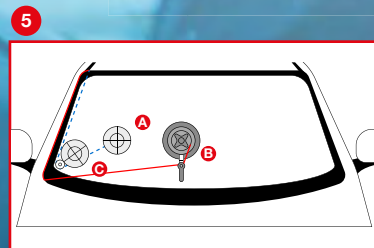
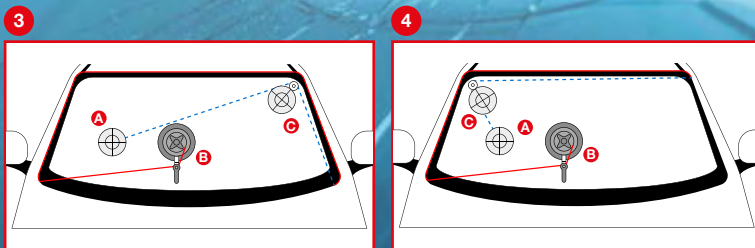
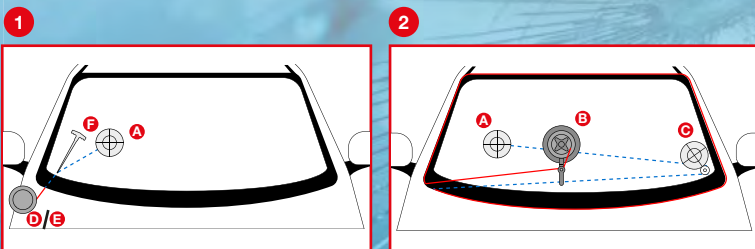

# 659,90

Compresi

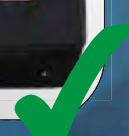



**NOVITÀ**

**1**  
Ulteriori informazioni

**ANCHE PER DOT5.1, ENV4 E ENV6**

- Dot3 ✓
- Dot4 ✓

0 20 mm

155 mm **20,90**

**150.1969** Tester liquido freni per DOT e ENV

**1**  
Ulteriori informazioni

**VITON®**  
**EKM**

**33,90**

**150.8258** Spruzzatore a pompa per detergente freni

**Specifico per detergente freni**

**2**  
Ulteriori informazioni

**15,90**

**150.1935** Kit ganci universali, deformabili

**2**  
Ulteriori informazioni

**19,90**

**150.2235** Kit ganci universali, rigidi

**12**  
Ulteriori informazioni

**69,90**

**150.2400** Serie di bussole speciali per il collegamento a vite della pinza freni

1/2" 11,5 mm 14 mm 15 mm 20 mm AS 22 mm

1/4" 9 x 20 mm

3/8" 7 x 72 mm  
7 x 92 mm  
9 x 50 mm  
11 x 100 mm

3/8" 7 x 25 - 8 x 25 mm

**41**  
Ulteriori informazioni

**115,90**

**150.1970** Serie di utensili per il riposizionamento dei pistoncini dei freni





Ulteriori informazioni

# IL GENIO UNIVERSALE



**UNIVERSAL**  
Per il 95% dei veicoli

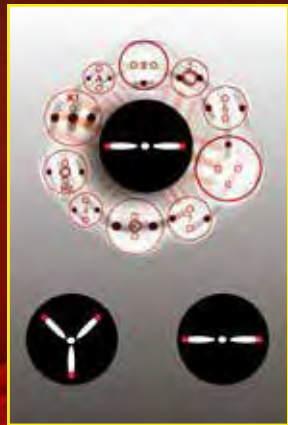

2 pin

3 pin



3/8"



4 pin



# 139,90



150.2440 Utensile di ripristino per pistoncini dei freni universale



Ulteriori informazioni

# 799,90



5L



160.0700 Dispositivo per la manutenzione del circuito freni KS5

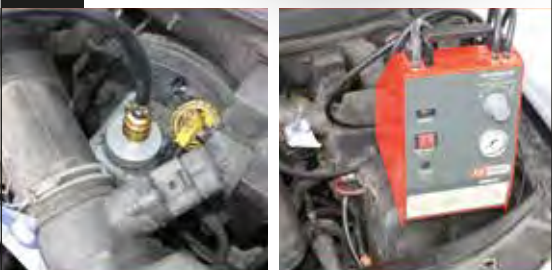

Ulteriori informazioni

# 66,90



360°

min. 18 mm

Regolabile in modo universale



Max. 70 mm

Min. 28 mm

160.0718 Adattatore bocchettone di sfiato universale, adattabile



Ulteriori informazioni

# TOYOTA & LEXUS

NOVITÀ



7,2 mm

1+2

# 21,90

160.0719 Adattatore bocchettone di sfiato universale per Toyota e Lexus



**i** **6**  
Ulteriori informazioni

1.200 mm

**STOP**

11 mm  
10 mm  
9 mm  
8 mm  
7 mm

**86,90**

160.0725 Serie di chiavi per spurgo freni

**i** **11**  
Ulteriori informazioni

**IL COMPLETO**

1.200 mm

**STOP**

9x12 mm 180 mm

11 mm 10 mm 11 mm 7 mm 11 mm 60 mm 70 mm 75 mm 85 mm 11 mm

**NOVITÀ**

**79,90**

518.0320 Serie utensili di spurgo freni per VAG

**i** **1**  
Ulteriori informazioni

4,75 mm (3/16") 21 mm 31 mm 41 mm 61 mm 76 mm

**46,90**

120.1006 Utensile di piegatura di tubi del freno

**i** **1**  
Ulteriori informazioni

4,75 mm (3/16") 6,35 mm (1/4")

**35,90**

120.1004 Utensile per piegare e raddrizzare tubi del freno

① Curvatura

② Duplicazione

③ Raddrizzamento

OUT IN



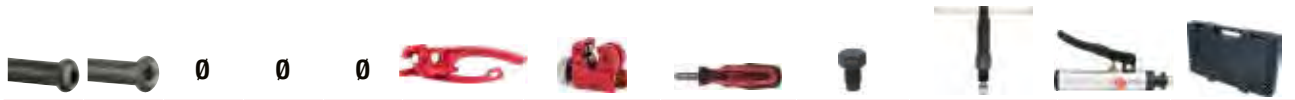

		DIN	SAE	4,75 mm	5,0 mm	6,0 mm	con piegatubi	con tagliatubi	con sbavatubi	meccanico	con vite di pressione idraulica	Pompa manuale	nella valigetta
1	122.1215	✓	✗	✓	✗	✗	✗	✗	✗	✓	✗	✗	✗
2	122.1290	✓	✓	✓	✓	✓	✓	✓	✓	✗	✓	✗	✓
3	122.1260	✓	✓	✓	✓	✓	✗	✗	✗	✗	✗	✓	✓

**i** **4**  
Ulteriori informazioni

**STOP**

**59,90**

4,75 mm

**1**

Serie utensili bordatubi per tubazioni dei freni universale da 4,75 mm FLAREFIXeco

122.1215

**i** **16**  
Ulteriori informazioni

## FLAREFIX

**DIN SAE**

**229,90**

**2**

FLAREFIX 1 Set di bordatura tubi universale per tubazioni dei freni con vite di pressione idraulica

122.1290

max. 2t

4,75(3/16") 5/8mm

3,0-12,0 mm

3,0-6,0 mm

3,0-16,0 mm

4,75-5,0 mm, SAE

6,0 mm, SAE

4,75-5,0-6,0 mm, SAE-90°

4,75-5,0 mm, DIN

6,0 mm, DIN

M12x1,25

4,75 mm, 3/16"

5,0 mm

6,0 mm

IDRAULICO, PRATICO, BUONO!

**i** **11**  
Ulteriori informazioni

## FLAREFIX II

### Hydraulic

**DIN SAE**

**369,90**

**3**

FLAREFIX 2 Set di bordatura tubi universale per tubazioni dei freni con cilindro idraulico

122.1260

max. 2,5t

4,75(3/16") 5/8mm

M12 x 1,25 mm

4,75-5,0 mm, SAE

6,0 mm, SAE

4,75-5,0-6,0 mm, SAE-90°

4,75-5,0 mm, DIN

6,0 mm, DIN

M12x1,25

4,75 mm, 3/16"

5,0 mm

6,0 mm





Ulteriori informazioni



**27,90**

3/8" Kit profilo speciale cambio olio per vite di scarico dell'olio in plastica, 9 pz

150.1040



Ulteriori informazioni



**89,80**

- Utensile per spianatura sedi guarnizioni delle viti di scarico olio
- La spianatura delle sedi guarnizioni garantisce una tenuta senza problemi delle viti di scarico
- Centraggio preciso e regolazione della superficie della guarnizione
- Serie che include adattatori per viti di scarico originali e/o viti ripara filetti
- In robusta valigetta di plastica

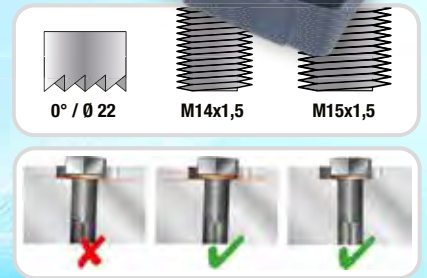

150.1485

Serie di utensili per viti di scarico e fresa per sedi guarnizioni



Ulteriori informazioni



**7,5 litri**

Ø 385 mm

**14,90**



150.9359

Bacinella 7,5 litri



**i**  **30**  
Ulteriori informazioni

1/2" 21 mm  
Ø 63 - 102 mm

**115,90**

**3/8"**

65-14, 65/67-14, 66-6, 68-14, 73-14, 74-15, 74/76-15, 75/77-15, 76-8, 76-12, 76-14, 76-30, 78-15, 80-15, 80/82-15, 86-18, 86-16, 90-15, 92-10, 93-15, 93-36, 93-45, 95-15, 96-18, 100-15, 106-15, 108-15, 108-18

**150.9350** **3/8" Chiave p.filtro olio, a tazza**



**i**  **24**  
Ulteriori informazioni

2,0 L

**120,90**

VW Lexus Lotus Ford Nissan  
Subaru Mitsubishi Land Rover Hyundai Audi  
Chrysler Toyota Citroën Volvo Cadillac  
Citroën Buick Volvo Buick Universale

**150.9130** **MASTER Set imbuto per lo riempimento olio, con braccio orientabile**



**i**  **4**  
Ulteriori informazioni

**PER VAG**

Con braccio orientabile per punti difficilmente accessibili

**19,90**

2,0 L

**150.9155** **Serie di imbuto di riempimento olio con braccio angolato girevole per VAG**





# PRONTI - PARTENZA - VIA!

In gomma piena



**NOVITÀ**

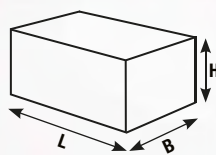

**i**  **1**  
Ulteriori informazioni

	Ricambi	L mm	B mm	H mm	
160.0476	1	160	120	20	6, <sup>90</sup> €
160.0477	1	160	120	30	9, <sup>90</sup> €
160.0478	1	160	120	40	12, <sup>90</sup> €
160.0479	1	160	120	60	18, <sup>90</sup> €
160.0480	1	160	120	80	22, <sup>90</sup> €
160.0481	1	160	120	100	28, <sup>50</sup> €
160.0482	1	160	120	115	33, <sup>00</sup> €
160.0483	1	116,5	116,5	36,5	8, <sup>00</sup> €
160.0499	1	160	120	85	23, <sup>90</sup> €

PE (polietilene)

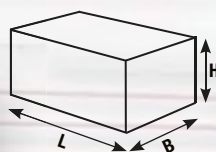

**NOVITÀ**

**i**  **1**  
Ulteriori informazioni

	Ricambi	L mm	B mm	H mm	
160.0437	1	250	150	55	20, <sup>90</sup> €
160.0438	1	250	150	100	35, <sup>00</sup> €
160.0486	1	340	150	55	26, <sup>50</sup> €
160.0489	1	340	130	100	41, <sup>00</sup> €

**i**  **1**  
Ulteriori informazioni

In gomma piena con anima rinforzata



**NOVITÀ**

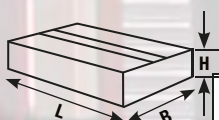

Ricambi	L mm	B mm	H mm		
160.0484	1	373	100	35	52, <sup>90</sup> €

**i**  **4**  
Ulteriori informazioni

In materiale plastico ad alta resistenza



**NOVITÀ**

- Model 3 ✓
- Model S ✓
- Model X ✓
- Model Y ✓



**i**  **4**  
Ulteriori informazioni

In gomma piena

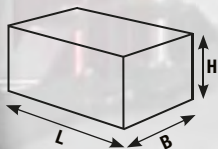

Ricambi	L mm	B mm	H mm		
160.0391-TD	4	155	125	35	48, <sup>90</sup> €

**i**  **1**  
Ulteriori informazioni

In gomma piena



**NOVITÀ**

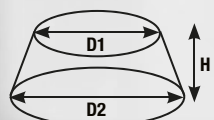

Ricambi	D1 mm	D2 mm	H mm		
160.0485	1	78	105	60	13, <sup>90</sup> €

160.0460 Tesla Model 3, S, X, Y

**39,<sup>00</sup>**



**i**  **1**  
Ulteriori informazioni

### In gomma e piastra d'acciaio

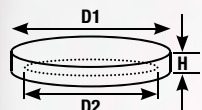

	D1 mm	D2 mm	H mm	Ravaglioli	Grazia	OMCN	Intertech	MAHA	Werther	Nussbaum	AMI	Twin Busch	Sirio	Space	Launch	RP Tools	J.A. Becker	ATH	HOFMANN	Hermann		
<b>A</b>	160.0463	120	113	22				✓														12,90 €
<b>B</b>	160.0465	123	108	25	✓				✓													12,90 €
<b>C</b>	160.0475	120	110	19													✓	✓	✓	✓		12,90 €

**i**  **1**  
Ulteriori informazioni

### In gomma

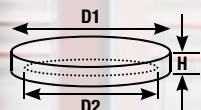

	D1 mm	D2 mm	H mm	Ravaglioli	Grazia	OMCN	Intertech	MAHA	Werther	Nussbaum	AMI	Twin Busch	Sirio	Space	Launch	RP Tools	J.A. Becker	ATH	HOFMANN	Hermann		
<b>A</b>	160.0466	125	120	24						✓	✓											17,90 €
<b>B</b>	160.0467	140	130	25								✓										8,90 €
<b>C</b>	160.0468	100	85	14	✓								✓	✓								7,00 €
<b>D</b>	160.0464	120	113	23				✓														7,00 €
<b>E</b>	160.0469	120	108	32								✓			✓	✓						11,90 €
<b>F</b>	160.0470	150	130	23	✓																	7,00 €
<b>G</b>	160.0471	140	125	30								✓										11,90 €
<b>H</b>	160.0472	130	125	14	✓																	9,90 €
<b>I</b>	160.0473	120	105	30								✓		✓								9,90 €
<b>J</b>	160.0474	120	110	19													✓	✓	✓	✓		7,00 €
<b>K</b>	160.0490	100	80	21	✓																	5,90 €
<b>L</b>	160.0491	120	108	26	✓	✓																7,00 €
<b>M</b>	160.0492	120	110	26	✓	✓																7,00 €
<b>N</b>	160.0493	145	108	24	✓																	11,90 €
<b>O</b>	160.0494	145	135	26	✓																	9,90 €
<b>P</b>	160.0495	160	135	28			✓															9,90 €
<b>Q</b>	160.0496	140	103	25						✓												11,90 €
<b>R</b>	160.0497	150	127	25	✓																	8,90 €
<b>S</b>	160.0498	140	132	28																		12,90 €



**i**  **1**  
Ulteriori informazioni

**9,90**

**Bacinella magnetica in plastica, forma inclinata, Ø 150 mm**

800.0156



**i**  **1**  
Ulteriori informazioni

**12,90**

**Leva p.valvola pneumatici in metallo, 330 mm**

150.2032



**i**  **1**  
Ulteriori informazioni

**35,90**

**Leva di montaggio pneumatici runflat**

911.8135



**i**  **1**  
Ulteriori informazioni

**52,90**

**Supporto magnetico, metallo, 390 mm**

800.0190



**i**  **1**  
Ulteriori informazioni

**29,90**

**Misuratore di pressione gomme**

515.1950

600 mm

0 - 12 bar

1/4" PT



**i**  **1**  
Ulteriori informazioni

**TARATO**

**65,90**

**Misuratore di pressione gomme tarato**

515.1960

400 mm

0 - 10 bar

1/4" PT



**i**  **5**  
Ulteriori informazioni

**68,90**

**Set utensili per vulcanizzazione pneumatici, incluso filetto da 100 mm**

150.1070

70 g

9 mm

60 x 100 mm

**OPZIONALE**

60 pz

**22,90**

150.1072



- 
- 
- 
- 
- 
- 
- 



**i**  **1**  
Ulteriori informazioni

**119,90**

Serie di pulizia per il mozzo ruota in alluminio Ø 150 mm, Ø interno 90 mm

100.5080

**OPZIONALE**

**39,90**

100.5077

90 mm

150 mm

**PRIMA:**

**DOPO:**

**i**  **4**  
Ulteriori informazioni

8 mm

10 mm

9 mm

8 mm

**NOVITÀ**

Serie di bussole speciali per cerchi in lega per OZ multipiezzo

**20,00**

515.0795  

**i**  **3**  
Ulteriori informazioni

**43,90**

1/2" Serie di bussole giraviti conico-elicoideali, 3 pz. 17 - 21 mm

913.1270   17 - 19 - 21 mm

**i**  **2**  
Ulteriori informazioni

19,5 mm

18,5 mm

21,5 mm

20,5 mm

**+**

Serie di bussole speciali per avvitatore a impulsi per cerchi in lega Ford, 18,5 / 19,5 / 20,5 / 21,5 mm

**35,90**

515.0895   18,5 - 19,5 - 20,5 - 21,5 mm

**i**  **1**  
Ulteriori informazioni

**PER MERCEDES**

max. 75 Nm

**19,90**

Prolunga 1/2" barra di torsione per bulloni ruote, 75 Nm

515.1491 





Ulteriori informazioni



### Set smontaggio ruote con antimanomissione

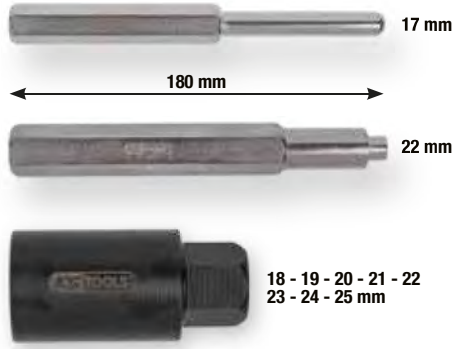

# 69,90

913.1480 18 - 19 - 20 - 21 - 22 - 23 - 24 - 25 mm



Ulteriori informazioni

### Serie di smontaggio per bulloni dei cerchi



Ø 21,5 mm



Ø 16 mm



Ø 21,5 mm

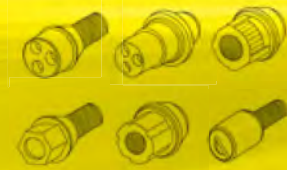

Ø 10,5 mm



Ø 9,5 mm



Utilizzabile su entrambi i lati



Con protezione per la mano



14 mm

Gommapiuma

# 154,90



3x Ø 25 mm

Ø 30 mm

38 mm

1/2"

24 mm

913.1430



GENIALI, UNIVERSALI - SI ADATTANO A TUTTI I PROFILI!





# 1/2" SERIE DI BUSSOLE PER AVVITATORI AD IMPULSI PER CERCHI IN LEGA

**1**

Ulteriori informazioni

21 mm 19 mm 17 mm

**21,90**

515.1070 1/2" 17 - 19 - 21 mm

**2**

Ulteriori informazioni

15 mm 17 mm 19 mm 21 mm 22 mm

**29,90**

515.0870 1/2" 15 - 17 - 19 - 21 - 22 mm

**3**

Ulteriori informazioni

**85,90**

17 mm 15 mm 19 mm 22 mm 23 mm 21 mm 17 mm 21 mm 24 mm

1/2" 15 - 17 - 19 - 21 - 22 - 23 - 24 mm

7/8" 17 mm MS21

515.0890

**4**

Ulteriori informazioni

15 mm 17 mm 19 mm 21 mm 22 mm 23 mm 24 mm 17 mm 21 mm

**169,90**

**VERAMENTE COMPLETO!**

515.0885 1/2" 15 - 17 - 19 - 21 - 22 - 23 - 24 mm 7/8" 17 mm MS21 17 - 19 - 21 mm 18,5 / 19,5 - 20,5 / 21,5 - 17,5 / 22,5 mm

	515.1072 15 mm	515.1073 17 mm	515.1075 19 mm	515.1076 21 mm	515.1077 22 mm	515.1078 23 mm	515.1079 24 mm	515.1089 Tesla 7/8"	515.2055 Mercedes 17 mm	515.2060 Hyundai KIA MS21	913.1271 Bussola graniti conico-eliconate 17 mm	913.1272 Bussola graniti conico-eliconate 19 mm	913.1273 Bussola graniti conico-eliconate 21 mm	515.0896 Ford 18,5 / 19,5 mm	515.0897 Ford 20,5 / 21,5 mm	515.0899 Ford 17,5 / 22,5 mm	515.1134 Prolunga per avvitatori ad impulsi, 75mm
<b>1</b>	X	✓	✓	✓	X	X	X	X	X	X	X	X	X	X	X	X	X
<b>2</b>	✓	✓	✓	✓	✓	X	X	X	X	X	X	X	X	X	X	X	X
<b>3</b>	✓	✓	✓	✓	✓	✓	✓	✓	✓	✓	X	X	X	X	X	X	X
<b>4</b>	✓	✓	✓	✓	✓	✓	✓	✓	✓	✓	✓	✓	✓	✓	✓	✓	✓



**1**  
Ulteriori informazioni

Ricaricabile con cavo USB-C (incluso)

**19,90**

**350 Lumen**

UV LED

con puntatore laser

**Lampada da ispezione LED COB**  
**Stripe da 350 lumen con LED spot**  
**UV e puntatore laser**

150.4400

165 mm

Li-Ion 800mAh

max. 3 h

3 h

IP20

+

+

+

**1**  
Ulteriori informazioni

**20,90**

**85 Lumen**

140 mm

25 m

**Lampada tascabile**  
**perfectLight 85 lumen**

2 x AAA

25 m

max. 10 h

IPX3

+

+

+

**1**  
Ulteriori informazioni

**NON PUOI NON AVERLO!**  
**PER L'OFFICINA E PER INTERVENTI ESTERNI**

**18,90**

MAX. 350 Lumen

MAX. 100 Lumen

270°

Interruttore del sensore

On/Off

Li-Ion 3,7 V 1200 mAh

Power Display

Sensore di movimento

XPE LED 2 livelli luminosità

COB LED 3 livelli luminosità

Impostazione della dimensione

max. 8 h

4,5 h

+

95 g

Modi

Modi	COB 100%	COB 40%	COB rot	XPE 100%	XPE 40%
LED	270° 3 Watt COB LED			1 Watt High Power XPE LED	
40%	350 LM	150 LM	-	100 LM	40 LM
	3 h	6 h	8 h	4 h	8 h

On/Off



**1**  
Ulteriori informazioni

# 22,90

**250 Lumen**

**500 Lumen**

360°

180°

ON OFF

USB

Batteria agli ioni di litio da 1200 mAh (inclusa)

3 batterie AAA (non comprese nella fornitura)

Funzione Power Bank USB inclusa

20 %	●
40 %	●●
60 %	●●●
80 %	●●●●
100 %	●●●●●

**150.4510**

max. 3 h

3 h

+

IP65

**1**  
Ulteriori informazioni

# 25,90

**130 Lumen**

**300 Lumen**

ON OFF

USB-A OUT

USB-C IN

Batteria agli ioni di litio integrata 1.200 mAh

20 %	●
40 %	●●
60 %	●●●
80 %	●●●●
100 %	●●●●●

**150.4505**

max. 3 h

3 h

+

IP65

**1**  
Ulteriori informazioni

# 18,90

**60 Lumen**

**150 Lumen**

360°

180°

ON OFF

Micro USB

20 %	●
40 %	●●
60 %	●●●
80 %	●●●●
100 %	●●●●●

**150.4495**

max. 3,5 h

2,5 h

IP20

**1**  
Ulteriori informazioni

# 39,90

**250 Lumen**

**550 Lumen**

ON OFF

USB-A OUT

USB-C IN

20 %	●
40 %	●●
60 %	●●●
80 %	●●●●
100 %	●●●●●

**150.4490**

max. 3,5 h

3 h

+

IP65



**i** **11**  
Ulteriori informazioni

**20-200 Nm**

con certificazione  
**DIN EN ISO 6789**  
**Certificazioni**  
Precisione

**1/2"**

**500 mm**

**159,90**

**125 mm**

**10 mm** **13 mm** **17 mm** **19 mm** **21 mm** **24 mm**

**17 mm** **19 mm** **21 mm**

**516.2400** **1/2"** **10 - 13 - 17 - 19 - 21 - 24 mm**

**i** **8**  
Ulteriori informazioni

**PER IL CAMBIO PNEUMATICI A TEMPO RECORD**

**21 mm** **19 mm** **17 mm**

**1/2"**

**1600 Nm**

**2 x**

**Ø 150 mm**

**0 - 12 bar**

**10 m**

**NOVITÀ**

**129,90**

**515.2100**

**THE DEVIL**

**ROBOTIT**

**Il Vs. partner**

**4 042146 956656**

**LL23-06IT\_TRZ\_EUR**

**KS Tools Werkzeuge - Maschinen GmbH**  
Seligenstädter Grund 10 - 12  
D-63150 Heusenstamm  
GERMANIA

Mail: [aftersales@kstools.com](mailto:aftersales@kstools.com)  
Web: [www.kstools.com](http://www.kstools.com)

La presente offerta sostituisce tutte le precedenti. KS Tools non si assume responsabilità per eventuali errori di stampa o di altra natura e si riserva il diritto di cambiamenti tecnici ai propri materiali e descrizioni. Prezzi netti suggeriti al pubblico in EURO I.V.A. esclusa, validi fino al 30/09/2024 o esaurimento scorte.